

# Beam Clay® Tennis Court Surfaces Natural Clay & Fast-Dry Clay

- Beam Clay® for Natural Clay Courts .....2-3
- Brick Dust Top-Dressing .....3
- Calcium Chloride Flakes .....3
- Calcium Chloride Pellets.....3
- Magnesium Chloride Flakes.....3
- Magnesium Chloride Pellets.....3
- Northeast® Fast-Dry Court Surfaces .....3
- Red Lava Dust Top-Dressing .....3
- Red Slate Top-Dressing .....3
- Har-Tru® Fast-Dry Court Surfaces .....4-6
- Recommendations for Constructing Clay Tennis Courts.....7
- Maintenance Recommendations for Natural Clay .....8
- Construction Recommendations for "Fast Dry" Courts ..... 9-12
- Rigid / Flexible Drag Mats ..... 13-14
- Scarifiers ..... 15-16
- Rollers – Hand & Tow Behind..... 17
- Yankee® Rakes, Scarifiers , Lutes ..... 18
- Midwest™ Rakes, Scarifiers, Lutes, Roller Squeegees ..... 19
- Midwest™ Squeegees & Brooms ..... 20
- Brooms ..... 21
- Dri-Ball Drying Agent ..... 22
- Tennis Court Shoe Brushes ..... 23
- Synthetic Turf for Tennis Courts.....24-26



For a wide range of tennis court accessories, please see our:  
**HAR-TRU® catalog & BALL NETTING, SYNTHETIC TURF & WINDSCREEN catalogs**

**YOUR "ONE-STOP" SOURCE FOR AMERICA'S BASEBALL, SOFTBALL & SPORTS SURFACES & SUPPLIES!**

*PRICES SUBJECT TO CHANGE & AVAILABILITY PLUS SHIPPING | VOLUME DISCOUNTS AVAILABLE | COOPERATIVE PURCHASING CONTRACT PRICING FOR 50 STATES*

**BEAM CLAY®**

Clay Tennis Court Surfaces

**THE VERDICT ON  
CLAY COURT SURFACES.****They're fun, healthy, and may determine the future of tennis.**

By Pat Hanssen

I believe in tennis. I believe in tennis because it fully engages you physically and mentally. I believe in tennis for the way it forces you to think for yourself, to learn and adapt, and to accept personal responsibility for winning and losing. Yes, I love tennis because it builds more than healthy bodies and active minds. Tennis builds character. And it's one of the few sports that can be played for a lifetime.

For the avid tennis player the game is a part of who they are. They live and breathe the sport; tell stories about the way they play, or the way they used to play. And their love for the game tells a story about them. Tennis is tied to their core values.

I'm convinced that clay court tennis connects more closely with a player's core values than the hard courts that pervade this country's tennis community. Sadly, most of today's U.S. courts are of the hard variety. Rather than keep alive the founding spirit of the game, which championed hard work, patience, strategy and endurance, today's hard court game has become one of power, aggression, speed and instant gratification.

I do not believe this style of tennis resonates with the most passionate of tennis fans and will even go so far as to say that the "new tennis" hurts our sport. It hurts recreational players because they receive the message that they are not strong enough to play. It hurts the seasoned and aging player because the power-speed game can injure the spirit and the body after the age of thirty.

If you have never played on clay, or perhaps only played infrequently, what I am saying may sound foreign to you. A first experience on clay has confounded and exasperated many a player. But those who take the time to familiarize themselves with the intricacies rarely want to go back to harder, faster surfaces.

Clay leaves players more physically and emotionally satisfied than other surfaces. The physical satisfaction comes from playing long points and long matches without over-stressing the knees, back and lower extremities. The emotional satisfaction comes from the thinking, creating and tactical responding that goes into each point and each match.

It is a surface that slows shots down, equalizing levels of play and allowing varying ages and ability levels to have fun playing together.

It is estimated that less than 20% of this nation's tennis courts are constructed of clay. Most of these are not real clay at all, but the easier-to-manage American variety known as **HAR-TRU®**. Clay court tennis has a long and distinguished history, both here and abroad, yet since the U.S. Open shifted from clay to hard courts, our country's focus has drifted from clay court tennis to hard courts and hard hitting. My wish is to preserve the playing of the game as it was originally intended. The future of tennis could very well depend on it. □

© 2006 HAR-TRU TENNIS

**Clay Courts Reward Players  
Who Think Before They Act.**

Tennis is the ultimate sport. And clay is the ultimate surface for the ultimate sport. I am not sure that those who are after the short-term rewards and success brought on by opponents blasting shots on hard, fast surfaces will ever truly be able to appreciate the sensation of playing on a court that rewards those who are creative, flexible and think before they act.

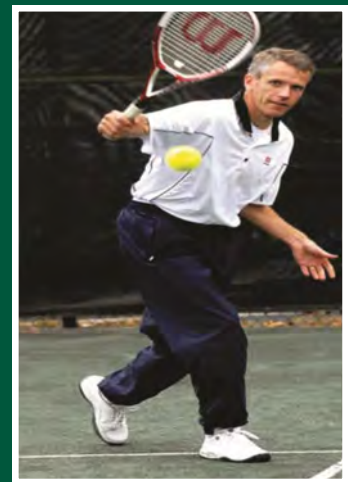
**YOUR "ONE-STOP" SOURCE FOR AMERICA'S BASEBALL, SOFTBALL & SPORTS SURFACES & SUPPLIES!**

PRICES SUBJECT TO CHANGE &amp; AVAILABILITY PLUS SHIPPING | VOLUME DISCOUNTS AVAILABLE | COOPERATIVE PURCHASING CONTRACT PRICING FOR 50 STATES

**PARTAC PEAT CORPORATION**  
ONE KELSEY PARK, GREAT MEADOWS, NEW JERSEY 07838800-247-BEAM (2326) • (908) 637-4191 • FAX (908) 637-8421  
www.beamclay.com • sales@beamclay.com  
Bid Term - 5/9/18 - 5/8/20; Extended to 5/8/21; Extended to 5/8/22

# BEAM CLAY<sup>®</sup>

## WHOLESALE PRICE LIST EFFECTIVE: JANUARY 1, 2021

### Beam Clay & Northeast "Fast-Dry" Clay Tennis Court Surfaces

#### TENNIS SURFACES

#### BEAM CLAY<sup>®</sup> FOR NATURAL CLAY TENNIS COURTS, F.O.B. NJ

New Construction: 4" recommended; approx. 30 tons per 1" compacted over 60' x 120' court.

BULK PER TON

PER BAG

Tennis Court Clay	- Red	(Extra Firm) 50 (50 lb. bags)/pallet
	- Orange	(Extra Firm) 50 (50 lb. bags)/pallet
	- Brown	(Extra Firm) 50 (50 lb. bags)/pallet
	- Grey	(Medium Firm) 50 (50 lb. bags)/pallet
	- Tan	(Medium Firm) 50 (50 lb. bags)/pallet
	- Orange	(Medium Firm) 50 (50 lb. bags)/pallet

TC-RXF-BULK	\$135
TC-OXF-BULK	\$125
TC-BXF-BULK	\$125
TC-GMF-BULK	\$115
TC-TMF-BULK	\$115
TC-OMF-BULK	\$125

TC-RXF-BAG	\$10.50
TC-OXF-BAG	\$9.50
TC-BXF-BAG	\$9.50
TC-GMF-BAG	\$7.50
TC-TMF-BAG	\$7.50
TC-OMF-BAG	\$9.50

Red Slate Top-Dressing	50 (50 lb.) bags/pallet
Red Brick Dust Top-Dressing	50 (50 lb.) bags/pallet
Red Lava Dust Top-Dressing	1.5 CY bulk bags, F.O.B. CA

RSTD-BULK	\$125
RDBD-BULK	\$165
LAVADUST-CYB	\$245/Bulk Bag

RSTD-BAG	\$8.75
RDBD-BAG	\$8.95
	—

Magnesium Chloride Flakes	50 (50 lb.) bags/pallet
Magnesium Chloride Pellets	48 (50 lb.) bags/pallet
Calcium Chloride Flakes	55 (50 lb.) bags/pallet
Calcium Chloride Pellets	55 (50 lb.) bags/pallet

MAG-FLAKES	\$22.95
MAG-PELLETS	\$31.95
CC-FLAKES	\$20.95
CC-PELLETS	\$22.95

FULL OR PARTIAL PALLETS: PALLET & COVER CHARGES: \$6.50/PALLET

NJ-PALLET

Please see instructions for constructing and maintaining natural clay tennis courts.

#### MIDWEST & SOUTH NATURAL TENNIS COURT CLAY

Extra Firm Red - one ton bulk bags, from regional plants

MW-XFR-BULK	\$80
-------------	------

MW-XFR-BB	\$595/Bulk Bag
-----------	----------------

#### WEST COAST NATURAL TENNIS COURT CLAY

Extra Firm Red- one ton bulk bags, from regional plants

WC-XFR-BULK	\$175
-------------	-------

WC-XFR-BB	\$265/Bulk Bag
-----------	----------------

POLYMERIZED CLAY—No water used to install or maintain—repels water yet stays firm & resilient. Extra Firm Red/Brown, 40 (50 lb.) bags/pallet.

- from AZ
- from NJ

—	HT-AZ-BAG	\$18.50
—	HT-NJ-BAG	\$28.50

POLYMERIZED TOP-DRESSING, one-ton bulk bag

- from AZ
- from NJ

—	HT-TD-AZ-BB	\$365
—	HT-TD-NJ-BB	\$725

#### NORTHEAST<sup>®</sup> TENNIS COURT FAST-DRY SURFACES

New Construction: 1,000 - 80 lb. bags (40 tons) = 1¼" loose per court = 1" compacted over a 60' x 120' court. Full pallets only from plants; any quantity from NJ.

**PLEASE NOTE:** Northeast pricing includes cost of pallet and shrink wrap, or pallet and bulk bag. Add \$6.50 for partial pallets from NJ.

NORTHEAST <sup>®</sup> (VT)	- Green	35 (80 lb. bags)/pallet
	- Green	48 (50 lb. bags)/pallet
	- Green	2,000 lb. Bulk Bags

NE-G80-VT	\$6.95
NE-G50-VT	\$4.75
NE-GBB-VT	\$195

NE-G80-NJ	\$9.75
NE-G50-NJ	\$6.50
NE-GBB-NJ	\$265

	- Red	35 (80 lb. bags)/pallet
	- Red	2,000 lb. Bulk Bag

NE-R80-VT	\$9.25
NE-RBB-VT	\$245/T

NE-R80-NJ	\$12.05
NE-RBB-NJ	\$315/T

MAGNESIUM CHLORIDE FLAKES Up to 48 (50 lb.) bags/pallet

NE-MAGFLK-VT	\$19.50
--------------	---------

—

Please see instructions for constructing and maintaining Fast-Dry Tennis Courts.



**YOUR "ONE-STOP" SOURCE FOR AMERICA'S BASEBALL, SOFTBALL & SPORTS SURFACES & SUPPLIES!**

PRICES SUBJECT TO CHANGE & AVAILABILITY PLUS SHIPPING | VOLUME DISCOUNTS AVAILABLE | COOPERATIVE PURCHASING CONTRACT PRICING FOR 50 STATES

# BEAM CLAY®

## WHOLESALE PRICE LIST EFFECTIVE: MAY 24, 2021

Har-Tru "Fast-Dry" Clay Tennis Court Surfaces

### TENNIS SURFACES

#### HAR-TRU® TENNIS COURT FAST-DRY SURFACES

New Construction: 1,000 - 80# bags (40 tons) = 1¼" loose per court = 1" compacted over a 60' x 120' per court. Full pallets only from plants; any quantity from NJ. **PLEASE NOTE:** Har-Tru pricing includes cost of pallet & stretch wrap, or pallet and bulk bag. Add \$5.50 for pallet covers (**VAPC**). Add \$6.50 for partial pallets from NJ (**NJ PALLET**).

Please see instructions for constructing and maintaining Fast-Dry Tennis Courts.

		PER BAG/PER PALLET F.O.B., VA PLANT	PER BAG/PER PALLET F.O.B., NJ WAREHOUSE
<b>Har-Tru® Surfacing</b>			
<b>TCMHT8014</b>	1.4 TON (80 LB. BAGS—35/PALLET)	\$9.50 / \$332.50	\$13.45 / \$470.75
<b>TCMHT8010</b>	1 TON (80 LB. BAGS—25/PALLET)	\$9.78 / \$244.50	\$13.85 / \$346.25
<b>TCMHT5014</b>	1.4 TON (50 LB. BAGS—56/PALLET)	\$6.44 / \$360.64	\$8.95 / \$501.20
<b>TCMHT5010</b>	1 TON (50 LB. BAGS—40/PALLET)	\$6.83 / \$273.20	\$9.35 / \$374
<b>TCMHT2000</b>	2,000 LB. BULK BAG	\$279.85	\$385
<b>TCMHT2500</b>	2,500 LB. BULK BAG	\$332.05	\$455
<b>TCMHT2800</b>	2,800 LB. BULK BAG	\$353.80	\$495
<b>HydroBlend For Sub-Irrigated Tennis Courts</b>			
<b>TCMHB8014</b>	1.4 TON (80 LB. BAGS—35/PALLET)	\$8.90 / \$311.50	\$12.85 / \$449.75
<b>TCMHB8010</b>	1 TON (80 LB. BAGS—25/PALLET)	\$9.22 / \$230.50	\$13.25 / \$331.25
<b>TCMHB5014</b>	1.4 TON (50 LB. BAGS—56/PALLET)	\$6.20 / \$347.20	\$8.75 / \$490
<b>TCMHB5010</b>	1 TON (50 LB. BAGS—40/PALLET)	\$6.55 / \$262	\$9.15 / \$366
<b>TCMHB2000</b>	2,000 LB. BULK BAG	\$266.80	\$375
<b>TCMHB2500</b>	2,500 LB. BULK BAG	\$304.50	\$435
<b>TCMHB2800</b>	2,800 LB. BULK BAG	\$343.65	\$485
<b>Coarse Blend For Sub-Irrigated Tennis Courts</b>			
<b>TCMCB7513</b>	1.3 TON (75 LB. BAGS—35/PALLET)	\$10.15 / \$355.25	\$13.95 / \$488.25
<b>American Red For Sub-Irrigated Tennis Courts</b>			
<b>TCMAR7014</b>	AMERICAN RED / 1.4 TON (70 LB. BAGS—40/PALLET)	\$13 / \$520	\$17.95 / \$718
<b>TCMAR2000</b>	AMERICAN RED (2,000 LB. BAG)	\$440.80	\$545
<b>European Red Clay</b>			
<b>EURORED</b>	(55 LB. BAGS—up to 80/pallet)	\$38.25	—
<b>Calcium Chloride Flakes (50 LB. BAGS—up to 48/pallet)</b>			
<b>SOLCALTCM</b>	CALCIUM CHLORIDE	\$25	—
<b>Magnesium Chloride Flakes (50 LB. BAGS—up to 48/pallet)</b>			
<b>SOLMAGTCM</b>	MAGNESIUM CHLORIDE	\$25	—
<b>#PLSSH</b>	Rain Cover Shrouds	\$6.00/pallet	

Please see instructions for constructing and maintaining Fast-Dry Tennis Courts.



**YOUR "ONE-STOP" SOURCE FOR AMERICA'S BASEBALL, SOFTBALL & SPORTS SURFACES & SUPPLIES!**

PRICES SUBJECT TO CHANGE & AVAILABILITY PLUS SHIPPING | VOLUME DISCOUNTS AVAILABLE | COOPERATIVE PURCHASING CONTRACT PRICING FOR 50 STATES

# BEAM CLAY®

Har-Tru® Fast-Dry Tennis Court Surfaces

**TIP**  
Fall top-dressing is just as effective as spring top-dressing and can allow a seasonal club to open its courts weeks earlier in the springtime.

## MAGNESIUM/ CALCIUM CHLORIDE

For dust control and moisture retention.  
The safest option for the Environment is Magnesium.



Chloride is available in 50-lb. bags.

SOLMAGTCM



Calcium Chloride is available in 50-lb. bags.

SOLCALTCM  
SOLCALWOT



## HAR-TRU® FAST-DRY TENNIS COURTS

We offer many packaging options for both the contractor and court owner. Most of our products come in 80-lb. bags with the option of getting that product in an Easy-Lift 50-lb. bag as well. The 50-lb. bag option is intended for those of us not used to handling bags all day. Some insurance company requirements in certain areas will dictate using a 50-lb. bag. Both the 80-lb. and the 50-lb. bags can be palletized and stretch wrapped for easy handling and weather protection.

For our contractors, we also stock and load Har-Tru or HydroBlend in bulk bags. These disposable bags are available in 2000-lb., 2500-lb. and 2800-lb. and can be taken right from the truck to the court with a forklift.



### < HAR-TRU®

Tennis court surfacing with binder. For use on Har-Tru courts with sprinkler systems.

Available in:

- 1.0 ton pallet with 80 lb. bags
- 1.4 tons per pallet with 80 lb. bags
- 1.0 ton pallet with 50 lb. bags
- 1.4 tons per pallet with 50 lb. bags
- 2000 lb. bulk bag
- 2500 lb. bulk bag
- 2800 lb. bulk bag

### HAR-TRU® COARSE BLEND >

Coarse surface manufactured for indoor and outdoor sub-irrigated courts where extra coarseness and sliding material are needed.

Available only in:

- 1.3 ton pallet with 75 lb. bags



### < HYDROBLEND

Tennis court surfacing material for sub-irrigated tennis courts.

Available in:

- 1.0 ton pallet with 80 lb. bags
- 1.4 tons per pallet with 80 lb. bags
- 2000 lb. bulk bag
- 2500 lb. bulk bag
- 2800 lb. bulk bag

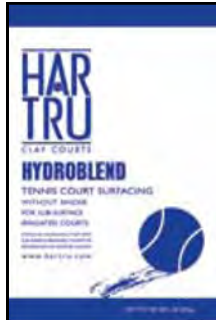

### AMERICAN RED CLAY >

Tennis court surfacing material for use on red sub-irrigated tennis courts or for top dressing a variety of natural clay courts.

Available only in:

- 1.4 ton pallet with 70 lb. bags
- 2000 lb. bulk bag



### < EUROPEAN RED CLAY

Imported from Europe this rich red brick dust is stunningly beautiful. It can be used for new court construction or top dressing existing red clay courts. It also works beautifully on red ClayTech where it gives the look of European red clay.  
Sold by the pallet. Comes in 55 LB bags.

**YOUR "ONE-STOP" SOURCE FOR AMERICA'S BASEBALL, SOFTBALL & SPORTS SURFACES & SUPPLIES!**

PRICES SUBJECT TO CHANGE & AVAILABILITY PLUS SHIPPING | VOLUME DISCOUNTS AVAILABLE | COOPERATIVE PURCHASING CONTRACT PRICING FOR 50 STATES

**BEAM CLAY®**

Har-Tru HydroCourt



HydroCourt is a self-regulating irrigation system that waters the court from below. Each court is constructed with six, fully lined, individually controlled cells. Each cell is monitored by a water control box allowing adjustments to be fine tuned to player preferences. Increasing the water in the control boxes increases the water level in the court. Once the appropriate water level is achieved a float valve and an overflow pipe inside the control box keep the water level constant. It's that simple!

HydroCourt is time tested in great numbers all across the globe. Well over 1,000 courts have been installed since 1985 in the US alone. And the HydroCourt system has been proven in every climate imaginable including countries like Canada, England, France, Japan, Qatar, Spain, Tortola, Turkey and more.

Why do people choose HydroCourt?

1. Perfect Playing Conditions 24/7. HydroCourts stay uniformly wet, smooth and firm for a consistent bounce and exceptional footing.
2. More available court time. HydroCourt technology eliminates midday shut downs and improves drainage. HydroCourts are playable during light rain and dry rapidly after a heavy one.
3. Maintenance is cut in half. Rolling is needed infrequently, brushing is required once a day and watering is completed automatically and uses 40% less.
4. Comfort. With water rising from below, some people feel like HydroCourts are air conditioned; they can be as much as 20 degrees cooler than a hard court.

**HydroCourt Brochure**  
**HydroCourt Construction Specifications (Updated)**  
**HydroCourt Owner-Users Manual (Updated)**  
**Maintenance Information**

"We needed a top-class surface for pros and members. The reduced amount of maintenance downtime and increased playing season has been an added bonus." –*Peter Elviss, Chief Executive, West Hants Club, Bournemouth, England*

"Our guests expect the very best amenities, service and playing experience and this is why we chose HydroCourt." –*Cliff Drysdale, ABC and ESPN commentator and Director of Tennis at The Ritz Carlton, Key Biscayne, FL*

"HydroCourt is ideal for our southwestern desert climate." –*Tim Bakels, General Manager and Vice President, Desert Highlands Association, Scottsdale, AZ*

"Tennis professionals know the advantage of clay courts, but dread the maintenance that comes with clay courts. HydroCourt has come to the rescue. Once you establish the settings, the court waters itself with no downtime, so members can enjoy playing tennis from morning till night. I highly recommend the HydroCourt system to anyone who is serious about building a clay court." –*Larry Schnall, Tennis Director, Marietta Country Club, Kennesaw, GA*

**YOUR "ONE-STOP" SOURCE FOR AMERICA'S BASEBALL, SOFTBALL & SPORTS SURFACES & SUPPLIES!**

PRICES SUBJECT TO CHANGE & AVAILABILITY PLUS SHIPPING | VOLUME DISCOUNTS AVAILABLE | COOPERATIVE PURCHASING CONTRACT PRICING FOR 50 STATES

# BEAM CLAY®

## Tennis Courts - Constructing Natural Clay Tennis Courts

### BEAM CLAY® HISTORY—ALMOST 100 YEARS!

**BEAM CLAY®** began in 1922 in preparation for the U.S. Open moving from the Germantown Cricket Club in Philadelphia to the West Side Tennis Club in Forest Hills – to provide red clay for the courts. All the tennis greats of that time played on **BEAM CLAY®**. Natural clay courts throughout the East Coast were constructed with **BEAM CLAY®**, many are still in use nearly 100 years later. We recently resurfaced the six natural clay courts at the Germantown Cricket Club. A natural clay court will outlast any other tennis court surface. It does require more annual maintenance, but natural clay courts and “fast-dry” clay courts provide a softer, more forgiving, surface for all ages and all levels of play.

### RECOMMENDATIONS FOR CONSTRUCTING NATURAL CLAY TENNIS COURTS (120' X 60')

#### SITE PREPARATION:

Clear site of all vegetation and top soil. Length of court, if possible, should be in a north/south position.

#### GRADING:

Natural clay courts need more slope for proper surface drainage than fast-dry courts, 1" in 20' (after compaction) versus 1" in 30' (after compaction) for fast-dry courts. Grade area on a true plane, preferably from side to side (but from end to end or from corner to corner are acceptable), or in the shortest direction for good drainage/water run-off.

#### DRAINAGE BED (Base Course):

Drainage bed may vary drastically depending on the existing sub-drainage conditions. Create a firm drainage base, minimum 3" deep (after compaction), of 3/4" minus crushed stone (with fines) maintaining above slope.

#### PRE-CLAY COURSE:

Apply 1/2" of stone screenings, true to grade.

#### CLAY PLAYING SURFACE:

##### For Natural Clay Courts

Apply approximately 5-1/4" of **BEAM CLAY® Tennis Court Clay** over court. This will compact to approximately 4". This will require approximately 120 tons of **BEAM CLAY® Tennis Court Clay**. It is generally best to construct a screed system with 2" x 6"s true to grade, installing loose clay between the planks and pulling a board across to maintain even grades.

After clay application, court should have a thorough soaking by rain to insure even distribution of moisture. Check for low spots; fill with **BEAM CLAY® Tennis Court Clay**; thoroughly saturate filled areas.

Once clay has dried enough that it will not adhere to a 1/2 ton roller, roll in both directions several times. Allow court to dry thoroughly and mat with a 6' wide rigid steel drag leveling mat to a powdery surface. Broom court in both directions.

After drying further, court surface will crack and continue to crack until sufficiently compacted.

After another wetting by rain and drying to proper moisture content, rework surface as above.

PLEASE NOTE: Clay courts will crack at first and must be rolled and broomed until cracks get smaller and disappear. A clay court that cracks the 1st year will in later years have a long useful life; a court that doesn't crack at first is too sandy, will wear out prematurely and will require more maintenance in later years. Natural clay court construction in northern climates is best done in the fall so that courts have a chance over winter to naturally compact.

Once cracking becomes sufficiently small (hair-line cracks) apply 1,000 lbs. of top-dressing and thoroughly broom in both directions. Roll again. If top-dressing is applied too soon, it will fill the cracks but (by working into the clay) shorten the long-term life of the court.

Apply 300 lbs. of magnesium or calcium chloride (flakes). After magnesium or calcium chloride thoroughly dissolves and court reaches proper moisture content (12 to 24 hours), court should be rebroomed and compacted (rolled).

Install marking tape and center pin. Ready for play.

After rain, re-broom and roll court when surface has dried. Apply top-dressing and calcium chloride as needed during season. Normally, 3-4 applications are sufficient for season.

### YOUR “ONE-STOP” SOURCE FOR AMERICA’S BASEBALL, SOFTBALL & SPORTS SURFACES & SUPPLIES!

PRICES SUBJECT TO CHANGE & AVAILABILITY PLUS SHIPPING | VOLUME DISCOUNTS AVAILABLE | COOPERATIVE PURCHASING CONTRACT PRICING FOR 50 STATES

# BEAM CLAY®

## Tennis Courts - Maintaining Natural Clay Tennis Courts

### RECOMMENDATIONS FOR RECONDITIONING NATURAL CLAY COURTS AFTER WINTER SEASON

1. Remove marking tapes and center pin. Sweep or blow top-dressing from court. In northern climates this is best done in the Fall when closing courts.
2. Scarify court with drag mat. Then broom in both directions, north/south and east/west.
3. After natural wetting by rain, check for low spots; fill with **BEAM CLAY® Tennis Court Clay**, working into the existing surface for good bonding. Thoroughly saturate filled areas.
4. When court has dried to sufficient moisture content, compact with 1/2 ton roller in both directions several times. Allow court to dry thoroughly and mat with a 6' wide rigid steel drag leveling mat to a powdery surface. Broom court in both directions.
5. Apply approximately 1,000 lbs. of top-dressing per court. Broom in both directions.
6. Apply 300 lbs. of magnesium or calcium chloride (flakes) per court. After flakes thoroughly dissolve and court reaches proper moisture content (12-24 hours), court should be re-broomed and compacted (rolled).
7. Reapply marking tapes and center pin.
8. After rain, re-broom and roll court when surface has dried. Apply top-dressing and calcium chloride as needed during season. Normally, 3-4 applications are sufficient for season.

### RECOMMENDATIONS FOR RESURFACING NATURAL CLAY TENNIS COURTS

1. Remove marking tape and center pin. Sweep or blow top-dressing from court.
2. Scarify court approximately 1/2" in depth.
3. Apply 1"+ of **BEAM CLAY® Tennis Court Clay**.
4. Rescarify to blend **BEAM CLAY®** with existing surface. Then drag mat entire court.
5. After a natural wetting by rain, check for low spots; fill with **BEAM CLAY® Tennis Court Clay**. Thoroughly saturate filled areas.
6. When court has dried to sufficient moisture content, compact with 1/2 ton roller in both directions several times. Allow court to dry thoroughly and mat with a 6' wide rigid steel drag leveling mat to a powdery surface. Broom court in both directions.
7. Court surface will continue to crack until sufficiently compacted. After another wetting by rain and drying to proper moisture content, rework surface as above.
8. **PLEASE NOTE:** Clay courts will crack at first and must be rolled and broomed until cracks get smaller and smaller and disappear. A clay court that cracks the 1st year will in later years have a long useful life; a court that doesn't crack at first is too sandy, will wear out prematurely, and will require more maintenance in later years.
9. Once cracking becomes sufficiently small (hair-line cracks) apply 1,000 lbs. top-dressing and thoroughly broom in both directions. Roll again.
10. Apply 300 lbs. of magnesium or calcium chloride (flakes) per court. After flakes thoroughly dissolve and court reaches proper moisture content (12 to 24 hours), court should be re-broomed and compacted (rolled).
11. Reapply marking tapes and center pin. Ready for play.
12. After rain, re-broom and roll court when surface has dried. Apply top-dressing and calcium chloride as needed during season. Normally, 3-4 applications are sufficient for season.

**YOUR "ONE-STOP" SOURCE FOR AMERICA'S BASEBALL, SOFTBALL & SPORTS SURFACES & SUPPLIES!**

PRICES SUBJECT TO CHANGE & AVAILABILITY PLUS SHIPPING | VOLUME DISCOUNTS AVAILABLE | COOPERATIVE PURCHASING CONTRACT PRICING FOR 50 STATES



# BEAM CLAY®

Tennis Courts - Constructing Fast-Dry Tennis Courts

## RECOMMENDATIONS FOR CONSTRUCTING & MAINTAINING FAST-DRY TENNIS COURTS

### CONSTRUCTION

Careful planning for site selection, orientation and layout will result in the most advantageous use of your court during the entire playing season — depending upon our geographic location. The following are our guidelines for site selection and construction of a typical fast-dry tennis court.

### SITE SELECTION AND PREPARATION

Orient your court layout as close to North and South as possible. Select a well drained site. All trees and above surface growth must be cleared as well as sub-surface growth such as root systems. Also, excavate all top soils and other unsuitable soils down to a clay or hardpan base. The excavation must be deep enough to allow the finished surface to be six inches above adjacent grade. If it is impractical to allow any required fill to settle over a winter, then the fill can be built up not more than six inch layers, and compact each layer. Add moisture when compacting extremely dry soils. Ninety-five percent compaction is recommended for the foundation.

### GRADING

Allow at least three feet beyond all curb and fence lines. More if a major cut is required. Rough grading should be within plus or minus one inch of finished sub-grade. Grade on a true plane, with a slope of one inch in thirty feet, preferably from side to side (but from end to end or from corner to corner also are acceptable), or in the shortest direction for good drainage/water run-off. The court should never be sloped from the net line to the baseline, from the baseline to the netline, from the side to the centerline or from the centerline to the sides.

### SPRINKLER SYSTEM

A sprinkler system is recommended instead of watering by hand. Piping and valves should be installed prior to leveling the stone. The standpipes and sprinkler heads should be installed after surface is completed. The system should have adequate sprinklers to provide full coverage of the court area. In some climates, a combination of sprinklers and sub surface irrigation can be used for supplying water to the court. Locations with little rainfall and expensive water costs should consider this combination of sub surface irrigation along with surface sprinklers. Extensive research should be made prior to the final decision on the sprinkler system as to water pressure and the gallons per minute.

### PERIMETER EDGING

An edging of brick or block set in cement mortar, treated wood timber or concrete should be installed around the entire perimeter of the court area. The finished curb elevation should be 1/2" below the finished court surface, after compaction, and the court surface should be tapered from approximately 2' out to meet the top of the edging.

### STONE BASE

The base of a fast-dry court must be stable and porous. Avoid materials that shift or crawl when rolled, or that move when subjected to freezing and thawing conditions. The base must be porous to absorb excess water from the surface. This is the fast-drying quality that allows play within a very short time after a rain. Also, the absorbed water is later fed back to the surface, maintaining proper moisture for best play. Too much compacting will create an impervious base, resulting in insufficient moisture penetration and exchange. 3/4" crushed stone with fines is the preferred base material. However, other materials, such as cinders, old slag or crushed pit gravel may be used.

The average thickness of the base is four inches, with the top one-half inch consisting of stone screenings.

### COURT SURFACING

On the finished stone base a 1-1/4" (one inch compacted) layer of fast-dry surfacing is installed. The material is laser-graded or spread with rakes and leveled by hand with a straightedge set atop screed strips. Since the base was placed to true grade, the screed strips are checked only for accuracy to assure uniform surface thickness. The dry surfacing is soaked with water and allowed to dry for 15 minutes to set up. Then a 600—1,000 pound roller is used to compact the material to one inch. Once the entire area is covered with surfacing, daily watering and rolling should be done for at least a week to insure proper compaction prior to heavy usage.

### NET POSTS

The net posts are positioned according to the U.S.T.A. The post footers should be 30" x 18" x 30" and filled with concrete up to 1" from the surface level (to top of stone base). After the concrete has set, the area is filled with surfacing to conform to the rest of the court.

### CENTERGUIDES & PLAYING LINES

Centerguides are galvanized pipe 12" - 18" long, installed in the ground and with a cross pin to attach the centerstrap hasp. The recommended line tapes are two inches wide and held in place with 2-1/2" - 3" nails. Position the lines in accordance with the U.S.T.A.

**YOUR "ONE-STOP" SOURCE FOR AMERICA'S BASEBALL, SOFTBALL & SPORTS SURFACES & SUPPLIES!**

PRICES SUBJECT TO CHANGE & AVAILABILITY PLUS SHIPPING | VOLUME DISCOUNTS AVAILABLE | COOPERATIVE PURCHASING CONTRACT PRICING FOR 50 STATES

# BEAM CLAY®

Tennis Courts - Constructing Fast-Dry Tennis Courts

## Construction & Installation

### Cross Section of Fast-Dry Tennis Court

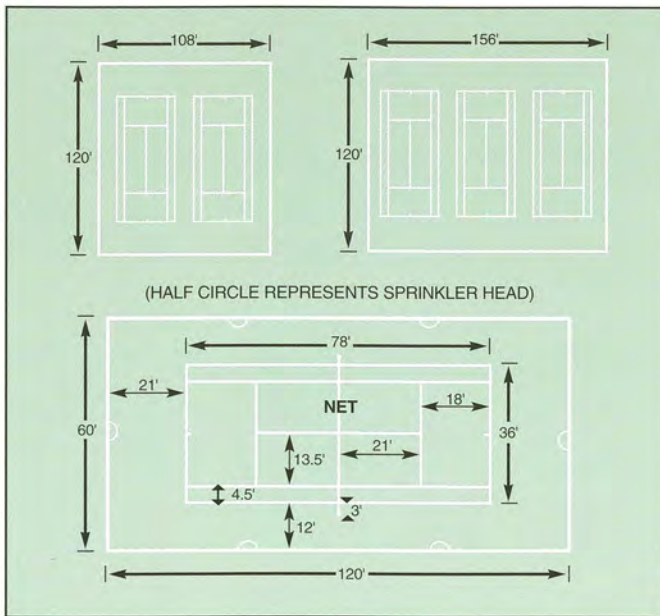
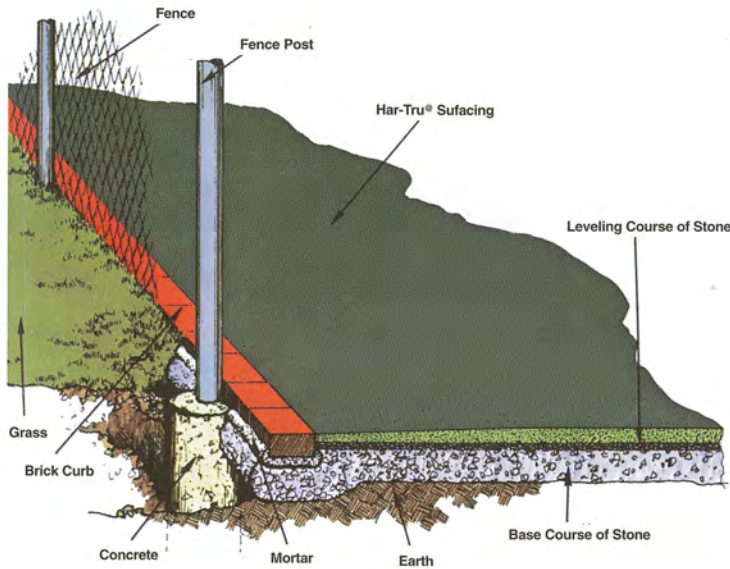

**YOUR "ONE-STOP" SOURCE FOR AMERICA'S BASEBALL, SOFTBALL & SPORTS SURFACES & SUPPLIES!**

PRICES SUBJECT TO CHANGE & AVAILABILITY PLUS SHIPPING | VOLUME DISCOUNTS AVAILABLE | COOPERATIVE PURCHASING CONTRACT PRICING FOR 50 STATES

**PARTAC PEAT CORPORATION**  
ONE KELSEY PARK, GREAT MEADOWS, NEW JERSEY 07838

800-247-BEAM (2326) • (908) 637-4191 • FAX (908) 637-8421  
www.beamclay.com • sales@beamclay.com  
Bid Term - 5/9/18 - 5/8/20; Extended to 5/8/21; Extended to 5/8/22

# BEAM CLAY®

Tennis Courts - Constructing Fast-Dry Tennis Courts

## BUILDING YOUR FAST-DRY TENNIS COURT

### TRADITIONAL BASE

For multiple courts and courts  
With heavy play.

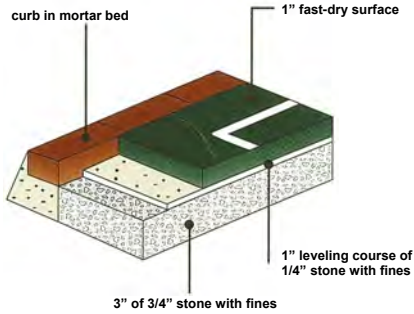

### MODIFIED SCREENING BASE

An acceptable alternative base for all  
applications especially where precise  
grade control can be achieved.

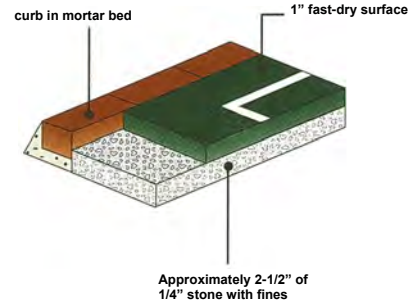

### CONVERSION OF HARD COURTS

Your old, cracked hard courts can be converted to soft fast-dry courts. You simply change the pitch with suitable fill and build right on top of your existing courts.

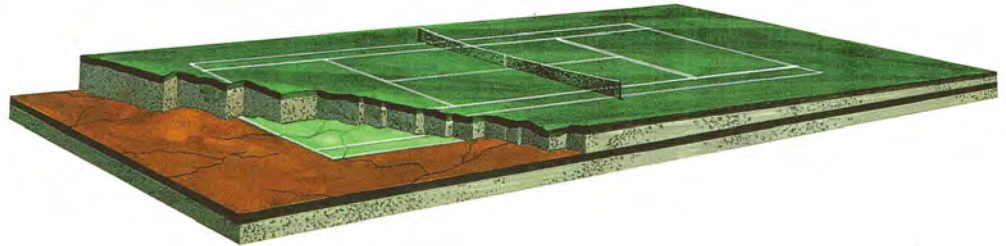

### IMPROVING CLAY COURTS

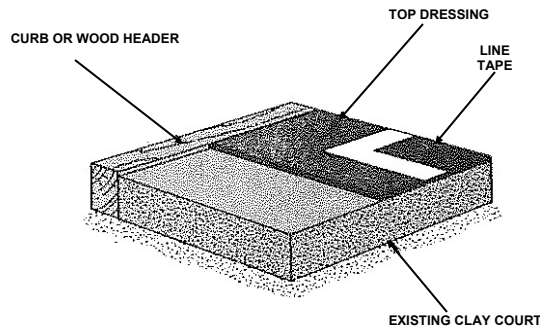

**YOUR "ONE-STOP" SOURCE FOR AMERICA'S BASEBALL, SOFTBALL & SPORTS SURFACES & SUPPLIES!**

PRICES SUBJECT TO CHANGE & AVAILABILITY PLUS SHIPPING | VOLUME DISCOUNTS AVAILABLE | COOPERATIVE PURCHASING CONTRACT PRICING FOR 50 STATES

# BEAM CLAY®

## Tennis Courts - Maintaining Fast-Dry Tennis Courts

### MAINTENANCE

The following suggestions for maintaining a fast-dry tennis court are simply basic guidelines. Local climate, soil conditions and court layout will determine specific maintenance procedures. Each court must establish its own maintenance policy, using our guidelines in conjunction with its own requirements and capabilities.

### BRUSHING

Brushing is most important in court maintenance, requiring a minimum amount of time. Brushing keeps the surface level, assuring an even distribution of the surface granules. At the end of each day's play, the court must be brushed. However, if the court is in continuous use, we recommend a mid-day brushing as well. Also, brush the court before rolling. Brush the court lengthwise and crosswise, taking particular care to eliminate accumulations of loose particles. When brushing, pull the brush behind you in a continuous pass, making a turn at the end of each sweep.

### WATERING

A fast-dry tennis court plays best when slightly damp, exhibiting its characteristic dark green or red color. A grayish or pink appearing surface indicates that the court needs watering. The amount of water you must apply to dampen the surface to its optimum playing condition depends upon the amount of water retained in the base at this time. In learning to judge the correct application, experience it through trial and error is your surest guide. We do recommend that the court be watered at night after it has been brushed. As noted elsewhere, a sprinkler system is most effective, repaying its cost in labor saved within the first year of use. However, if hand watering, the hose nozzle should not be pointed down toward the surface. Always hold the nozzle at waist level and direct the spray horizontally so the water falls in a shallow arc.

### ROLLING

A newly constructed court should receive one or two consecutive rollings — lengthwise and crosswise — each day for a minimum period of a week. Following these initial rollings, the court should be rolled at least once a week and after every appreciable rainfall.

A 600-1,000 pound roller provides the best results.

Rolling is most effective when the court surface is damp or semi-damp. Do not roll an absolutely dry or an extremely wet court. If the court surface adheres to the roller, or tends to shift or move when rolling, the court must be allowed to dry before further rolling.

The more rolling a court receives, the firmer the surface — resulting in a faster playing court.

### PATCHING

If a small hole or indentation appears on the surface, it should be repaired immediately, thus avoiding more extensive and difficult repair work later. For example, if a small depression (about 1/2" deep) appears near the base line and does not disappear with ordinary maintenance, then the area must be patched. Using a hand trowel, square end shovel or similar tool, cut out the area down to the stone base material. Refill the hole with regular fast-dry surfacing material, applied dry, then compacted and leveled to the surrounding area. The material is easily leveled with a straight-edged piece of wood drawn across the area in a manner similar to concrete floating. After the area is leveled, apply enough water to soak the patch. When the water disappears, roll the patch which should become firm and ready to play on. These instructions apply to all size patches.

### ANNUAL MAINTENANCE

Annual replacement of surfacing is necessary due to weather erosion and player movement. Therefore, it is recommended that one ton minimum (2,000 lbs.) of new surfacing material be placed on the court each year.



#### **Brushing the Court**

The courts should be brushed by pulling the drag broom over the entire surface of the court at the end of each day's play or more often as needed.



#### **Sweeping the Lines**

The lines should be swept by pushing a rotary line sweeping brush over the lines to remove the surface particles.



#### **Rolling the Court**

The rolling of the court is recommended once a week and after each appreciable rain in order to assure proper compaction.

**YOUR "ONE-STOP" SOURCE FOR AMERICA'S BASEBALL, SOFTBALL & SPORTS SURFACES & SUPPLIES!**

PRICES SUBJECT TO CHANGE & AVAILABILITY PLUS SHIPPING | VOLUME DISCOUNTS AVAILABLE | COOPERATIVE PURCHASING CONTRACT PRICING FOR 50 STATES

**PARTAC PEAT CORPORATION**  
ONE KELSEY PARK, GREAT MEADOWS, NEW JERSEY 07838

800-247-BEAM (2326) • (908) 637-4191 • FAX (908) 637-8421  
www.beamclay.com • sales@beamclay.com

Bid Term - 5/9/18 - 5/8/20; Extended to 5/8/21; Extended to 5/8/22

# BEAM CLAY®

Tennis Court - Drag Mats

**WHOLESALE PRICE LIST**  
EFFECTIVE: JANUARY 1, 2021

## DRAG MATS

For use when building tennis courts or reconditioning in Spring.

### RIGID DRAG MATS, HEAVY-DUTY with Rope & Handle.

Use cutting lip down for aggressive leveling, up for normal smoothing.

	<b>Heavy-Duty - Rigid Mat - Does not roll up (from NJ Plant):</b>	
#RIDM3x3-1/2	3' Wide x 3½' Long (27 lbs.)	\$175
#RIDM4X3-1/2	4' Wide x 3½' Long (36 lbs.)	\$205
#RIDM5X3-1/2	5' Wide x 3½' Long (45 lbs.)	\$245
#RIDM6X3-1/2	6' Wide x 3½' Long (54 lbs.)	\$295
	<b>Standard-Duty - Rigid Attachment but mat rolls up (from PA Plant):</b>	
#RIDM4X18	4' Wide x 18" Long (24 lbs.)	\$105
#RIDM4X2	4' Wide x 2' Long (23 lbs.)	\$125
#RIDM4X3	4' Wide x 3' Long (33 lbs.)	\$145
#RIDM6X18	6' Wide x 18" Long (35 lbs.)	\$145
#RIDM6X2	6' Wide x 2' Long (33 lbs.)	\$180
#RIDM6X3	6' Wide x 3' Long (44 lbs.)	\$215

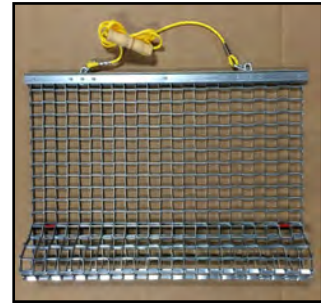
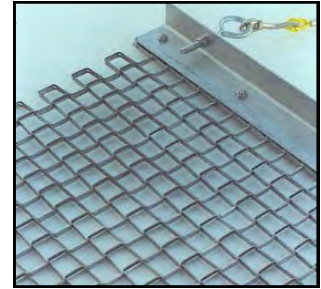

**FLEXIBLE DRAG MATS, STANDARD-DUTY** 3/8" x .046" galvanized steel with Rope & Handle. Red spacers are placed in the two corners that do not have the attachment. The mat can roll up from left to right with the drag attachment bar on the right. Custom sizes available. Mats are generally rolled and a cardboard sleeve is placed over each end for shipping with additional cardboard around the middle to place shipping labels.

**Most Popular Sizes:** From PA plant allow 2-3 weeks lead time. Most popular sizes normally in stock from NJ.

		NJ PLANT #	NJ PLANT	PA PLANT
FTDM4X6-PA	4' Wide x 6' Long (42 lbs.)*, F.O.B. PA	FTDM4X6-NJ	\$265	\$245
FTDM5X3-PA	5' Wide x 3' Long (29 lbs.)	FTDM5X3-NJ	\$190	\$170
FTDM5X5-PA	5' Wide x 5' Long (46 lbs.)	FTDM5X5-NJ	\$285	\$265
FTDM6X3-PA	6' Wide x 3' Long (35 lbs.)*	FTDM6X3-NJ	\$225	\$205
FTDM6X6-PA	6' Wide x 6' Long (64 lbs.)	FTDM6X6-NJ	\$395	\$365
FTDM6X10-PA	6' Wide x 10' Long (101 lbs.)	FTDM6X10-NJ	\$620	\$585
FTDM8X8-PA	8' Wide x 8' Long (110 lbs.)	FTDM8X8-NJ	\$760	\$725
FTDM2X3-1/2-PA	Small Flexible Drag Mat for Mounds - 2' Wide x 3½' Long (13 lbs.)*	FTDM2X3-1/2-NJ	\$105	\$95
FTDM4X2-PA	Small Flexible Drag Mat for Mounds - 4' Wide x 2' Long (16 lbs.)	FTDM4X2-NJ	\$110	\$100

**Some Other Common Sizes:**

FTDM3X3-PA	3' Wide x 3' Long (17 lbs.)	\$110	} UPS
FTDM3X4-PA	3' Wide x 4' Long (22 lbs.)*	\$135	
FTDM3X5-PA	3' Wide x 5' Long (27 lbs.)*	\$165	
FTDM4X5-PA	4' Wide x 5' Long (35 lbs.)	\$179	} Common Carrier
FTM6X18"-PA	6' Wide x 18" Long (20 lbs.)	\$120	
FTDM6X4-PA	6' Wide x 4' Long (42 lbs.)	\$260	
FTDM6-1/2X2-PA	6-½' Wide x 2' Long (26 lbs.)	\$160	
FTDM6-1/2X4-PA	6-½' Wide x 4' Long (48 lbs.)	\$280	
FTDM8X3-PA	8' Wide x 3' Long (45 lbs.)	\$300	} Common Carrier
FTDM8X4-PA	8' Wide x 4' Long (58 lbs.)	\$385	
FTDM8X6-PA	8' Wide x 6' Long (84 lbs.)	\$550	
FTDM10X4-PA	10' Wide x 4' Long (72 lbs.)	\$475	} Common Carrier
FTDM10X6-PA	10' Wide x 6' Long (104 lbs.)	\$685	
FTDM10X10-PA	10' Wide x 10' Long (160 lbs.)	\$1,100	
FTDM12X6-PA	12' Wide x 6' Long (125 lbs.)	\$825	} Common Carrier
FTDM12X12-PA	12' Wide x 12' Long (240 lbs.)	\$1,575	

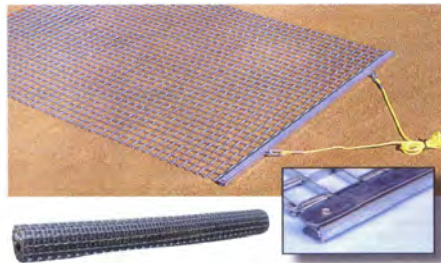

Up to 6' Wide mats ship UPS. Common carrier for larger widths.

**YOUR "ONE-STOP" SOURCE FOR AMERICA'S BASEBALL, SOFTBALL & SPORTS SURFACES & SUPPLIES!**

PRICES SUBJECT TO CHANGE & AVAILABILITY PLUS SHIPPING | VOLUME DISCOUNTS AVAILABLE | COOPERATIVE PURCHASING CONTRACT PRICING FOR 50 STATES

# BEAM CLAY®

Tennis Court Drag Mats—More

**WHOLESALE PRICE LIST**  
 EFFECTIVE: JANUARY 1, 2021

**FLEXIBLE DRAG MAT**

Same construction as Flexible Drag Mats on preceding page, except includes heavy duty angle iron across front of mat & a heavy duty chain for pulling.

**#10500** 6'6" Wide x 4' Long (68 lbs.)

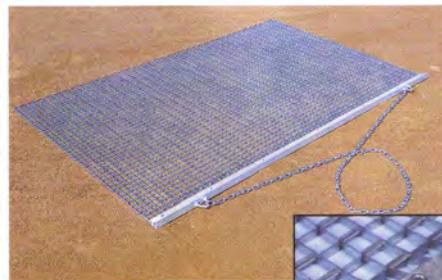

**\$350**

**FLEXIBLE INFIELD DRAG MAT**

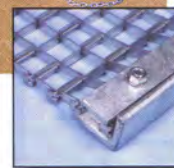

**6' LEVELING BAR**

Designed to attach to a 6' wide flexible drag mat to make more effective use on infields. Shave off high spots and fill in the low areas. Bent wings prevent material from spilling over the edges. 6' wide, 3/8" thick, powder coated steel construction. Quick connectors are included for attaching a flexible drag mat. Order drag mat separately (on preceding page).



**#1237009** (15 lbs.)



Order drag mat separately (on preceding page).

**\$185**

**HEAVY DUTY FLEXIBLE DRAG MAT**

Over 3 times the strength of the standard flexible drag. 1/2" x .062" galvanized steel 1" x 1" 3.5 lbs. per sq. ft. weight. Comes complete with steel drag attachment with forged eye bolts, rope & handle.

- HDFDM4X4** 4' Wide x 4' Long (64 lbs.)
- HDFDM6X4** 6' Wide x 4' Long (96 lbs.)
- HDFDM6X5** 6' Wide x 5' Long (117 lbs.)
- HDFDM6X6** 6' Wide x 6' Long (138 lbs.)
- HDFDM8X6** 8' Wide x 6' Long (184 lbs.)
- HDFDM8X8** 8' Wide x 8' Long (240 lbs.)

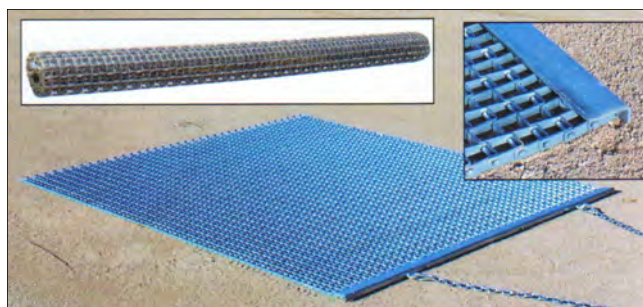

**\$275**

**\$395**

**\$475**

**\$555**

**\$735**

**\$950**

**YOUR "ONE-STOP" SOURCE FOR AMERICA'S BASEBALL, SOFTBALL & SPORTS SURFACES & SUPPLIES!**

PRICES SUBJECT TO CHANGE & AVAILABILITY PLUS SHIPPING | VOLUME DISCOUNTS AVAILABLE | COOPERATIVE PURCHASING CONTRACT PRICING FOR 50 STATES

# BEAM CLAY®

Tennis Court Scarifiers

**WHOLESALE PRICE LIST**  
 EFFECTIVE: JANUARY 1, 2021

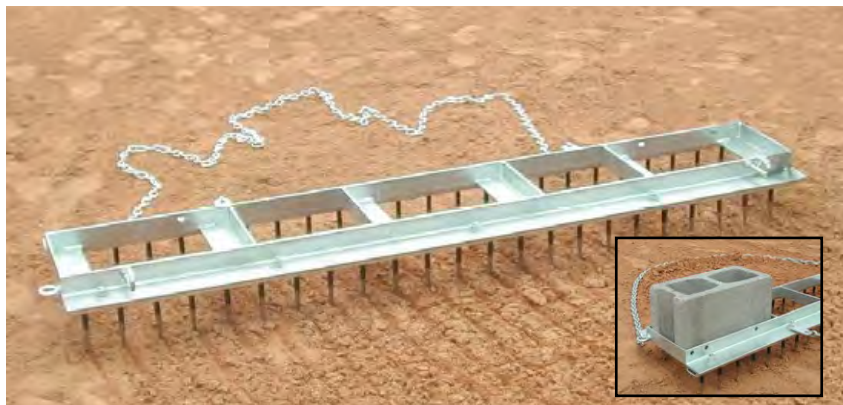

### **TENNIS COURT SCARIFER**

- Designed to break up clay
- Features forty-six 4.5" steel cutting teeth
  - Frame is hot dipped galvanized steel
  - Heavy duty pull chain included
  - Recommended to be pulled by a tractor
  - Grooming drag chain included
  - Flip over and use as leveling drag
  - Weight : 88 lbs.

**BSDRAG**

Size - 14"W x 6'L

**\$435**

### **TENNIS COURT SCARIFER WITH WHEELS**

- Hot dipped galvanized steel frame
- Uses 4.5" sharpened and hardened steel cutting teeth
- No-flat wheels allow you to roll for transport
- Pull chain is provided
- Hooks on rear allows for attachment of drag mat
- Remove wheels to turn groomer over and use as a leveling sled
- Recommended to be pulled by a tractor

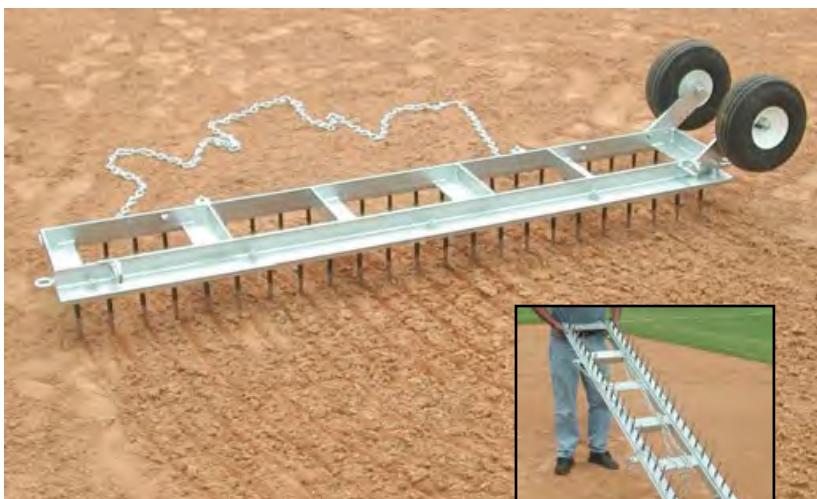

**BSDDRAG** Scarifier w/Wheels, Wt 100 lbs.

**\$545**

**BSDDWHL** Set of 2 Wheels

**\$195**

**ZBDNAIL** Repl. Teeth (117 lbs.)

**\$145**

**YOUR "ONE-STOP" SOURCE FOR AMERICA'S BASEBALL, SOFTBALL & SPORTS SURFACES & SUPPLIES!**

PRICES SUBJECT TO CHANGE & AVAILABILITY PLUS SHIPPING | VOLUME DISCOUNTS AVAILABLE | COOPERATIVE PURCHASING CONTRACT PRICING FOR 50 STATES

**PARTAC PEAT CORPORATION**  
 ONE KELSEY PARK, GREAT MEADOWS, NEW JERSEY 07838

800-247-BEAM (2326) • (908) 637-4191 • FAX (908) 637-8421  
 www.beamclay.com • sales@beamclay.com  
 Bid Term - 5/9/18 - 5/8/20; Extended to 5/8/21; Extended to 5/8/22

# BEAM CLAY®

**WHOLESALE PRICE LIST**  
 EFFECTIVE: JANUARY 1, 2021

## Tennis Court Resurfacing/Scarification Tools

### COURT DEVIL SCARIFIERS

Great for loosening & scarifying your tennis court surfaces.

**#146-3409 COURT DEVIL** —Weight 105 lbs., width 48".

**\$1,595**

**#146-3408 COURT DEVIL JR**—Weight 85 lbs., width 16".

**\$1,250**



### TRU-FLOW TOP-DRESSERS

This top-dresser offers unmatched performance in distributing Fast-Dry Tennis Court Surfacing.

Tru-Flow spreaders handle the toughest of conditions. For top-dressing to be effective, it needs to be applied as uniformly as possible. Tru-Flow's unique 8" dispersal drum is encased in expanded metal. Conventional drop spreaders rely on gravity to help release the Fast-Dry from its hopper, but the Tru-Flow pulls the surface out of the hopper and on to the court with unmatched consistency.

24" Hand Spreader holds up to four 80 lb. bags. Simply bolt on the handle and you are ready to start your pre-season renovation.

**#124-3069** - 24" Hand Spreader

**\$950**

**#124-3065** - 36" Tow Spreader

**\$2,473**

**#124-3066** - 54" Tow Spreader

**\$2,894**



**YOUR "ONE-STOP" SOURCE FOR AMERICA'S BASEBALL, SOFTBALL & SPORTS SURFACES & SUPPLIES!**

PRICES SUBJECT TO CHANGE & AVAILABILITY PLUS SHIPPING | VOLUME DISCOUNTS AVAILABLE | COOPERATIVE PURCHASING CONTRACT PRICING FOR 50 STATES

**PARTAC PEAT CORPORATION**  
 ONE KELSEY PARK, GREAT MEADOWS, NEW JERSEY 07838

800-247-BEAM (2326) • (908) 637-4191 • FAX (908) 637-8421  
 www.beamclay.com • sales@beamclay.com  
 Bid Term - 5/9/18 - 5/8/20; Extended to 5/8/21; Extended to 5/8/22



# BEAM CLAY®

**WHOLESALE PRICE LIST**  
 EFFECTIVE: APRIL 23, 2021

Tennis Court Rollers—Hand & Tow-Behind

## TENNIS COURT ROLLERS

### HAND ROLLER

18" Diameter x 24" Wide, 14 gauge (1/12") all steel design, bronze bushings, fill with water to create desired weight. Ships in two pieces, minor assembly required. Wt. 45 lbs. (empty), 200 lbs. (full).

#85750

\$325



See Tennis Catalog for the full line of **Har-Tru®/Lee®** Rollers.

See Tennis Catalog for the full line of **Brutus™** Rollers.

### HAND ROLLERS WITH CONVERTIBLE HANDLES

For hand pushing or towing. 11 gauge (1/8") steel with bronze bushings, scraper bars, and rolled edges. (F.O.B., MN)

#4908024 18"D x 24"W ( 74 lbs. empty/280 lbs. full, 88 lbs. shipping)

#4908036 18"D x 36"W (108 lbs. empty/434 lbs. full, 166 lbs. Shipping)

#4908048 18"D x 48"W (138 lbs. empty/572 lbs. full, 205 lbs. shipping)

#49248024 24"D x 24"W ( 96 lbs. empty/488 lbs. full, 115 lbs. shipping)

#49249848 24"D x 48"W (244 lbs. empty/1,005 lbs. full, 450 lbs. shipping, Tow-hitch only)

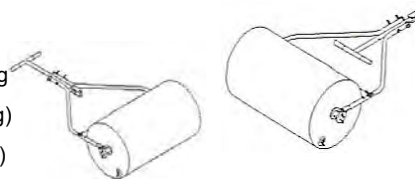

\$735

\$1,030

\$1,145

\$825

\$1,700

### TOW-BEHIND ROLLERS

When drained, both gang rollers can be folded up for easy transport or storage. All drums are 11-gauge (1/8") steel with an internal coating of rust inhibitor. All units come with adjustable scrapers (Spring Tensioned) and with replaceable axle bearings with grease fittings.

#499 **6' GANG ROLLER** Three 18"D x 24"W Rollers With Gang Hitch  
 (272 lbs. empty, 923 lbs. full, 440 lbs. shipping)

#496 **12' GANG ROLLER** Three 18"D x 4-foot Rollers With Gang Hitch  
 (464 lbs. empty, 1,766 lbs. full, 660 lbs. shipping)

#4926 **12' GANG ROLLER** Three 24"D x 4-foot Rollers With Gang Hitch  
 (750 lbs. empty, 3,100 lbs. full, 1,047 lbs. shipping)

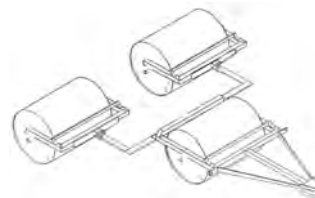

\$2,350

\$3,155

\$4,800

**YOUR "ONE-STOP" SOURCE FOR AMERICA'S BASEBALL, SOFTBALL & SPORTS SURFACES & SUPPLIES!**

PRICES SUBJECT TO CHANGE & AVAILABILITY PLUS SHIPPING | VOLUME DISCOUNTS AVAILABLE | COOPERATIVE PURCHASING CONTRACT PRICING FOR 50 STATES

# BEAM CLAY®

## WHOLESALE PRICE LIST EFFECTIVE: JANUARY 1, 2021

Yankee® Rakes, Scarifier/Lutes, Roller Squeegees & Litter Picks for Tennis Courts

### YANKEE®/NEW ENGLAND ALUMINUM RAKES

Light Yet Sturdy With 66" Gold Anodized or Gold Powder Coated Handles (84" Handles available @ \$10 additional). Side braces bolt through top of handles.

#### YANKEE® ALUMINUM RAKES WITH ROUND SIFTING TEETH AND STRAIGHT EDGE

				2 PACK
<b>NERS24 0524</b>	24" Blade (3 lbs.)	\$64.95	<b>NERS24-2P</b>	\$120
<b>NERS30 0530</b>	30" Blade (3 lbs.)	\$67.95	<b>NERS30-2P</b>	\$126
<b>NERS36 0536</b>	36" Blade (4 lbs.)	\$71.95	<b>NERS36-2P</b>	\$133
<b>NERS42 0542</b>	42" Blade (5 lbs.)	\$80.95	<b>NERS42-2P</b>	\$150
<b>NERS48 0548</b>	48" Blade (5 lbs.)	\$85.95	<b>NERS48-2P</b>	\$157



#### YANKEE® ALUMINUM RAKES WITH STRAIGHT TEETH AND STRAIGHT EDGE

<b>NERC14 0914</b>	14" Blade (3 lbs.)	\$45.95	<b>NERC14-2P</b>	\$84
<b>NERC24 0924</b>	24" Blade (3 lbs.)	\$60.95	<b>NERC24-2P</b>	\$112
<b>NERC30 0930</b>	30" Blade (3 lbs.)	\$63.95	<b>NERC30-2P</b>	\$118
<b>NERC36 0936</b>	36" Blade (4 lbs.)	\$67.95	<b>NERC36-2P</b>	\$123
<b>NERC42 0942</b>	42" Blade (5 lbs.)	\$75.95	<b>NERC42-2P</b>	\$140
<b>NERC48 0948</b>	48" Blade (5 lbs.)	\$79.95	<b>NERC48-2P</b>	\$148



#### REPLACEMENT PARTS FOR YANKEE® RAKES

<b>NERBKS24</b>	Brace and Plug Replacement Kit— two 15" Braces & Hardware (For 24" / 30" / 36" Rakes) <b>#BPRK-24</b>	\$26.00
<b>NERBKS42</b>	Brace and Plug Replacement Kit— two 19" Braces & Hardware (For 42" / 48" Rakes) <b>#BPRK-42</b>	\$27.00
<b>NERBKH66</b>	66" Replacement Handle with Standard Grip <b>#66RH w/SG</b>	\$30.00
<b>NERBKH84</b>	84" Replacement Handle with Standard Grip <b>#84RH w/SG</b>	\$30.00

#### YANKEE® SPECIALTY RAKES (PLUG PUSHERS & TENNIS COURT SCARIFIER/LUTES)

##### PLUG PUSHERS (DOUBLE-EDGED SMOOTH BLADES)

<b>NERL24 0624</b>	24" Blade (3 lbs.)	\$52.95	<b>NERL24-2P</b>	\$95
<b>NERL30 0630</b>	30" Blade (3 lbs.)	\$55.95	<b>NERL30-2P</b>	\$102
<b>NERL36 0636</b>	36" Blade (4 lbs.)	\$58.95	<b>NERL36-2P</b>	\$106
<b>NERL42 0642</b>	42" Blade (4 lbs.)	\$65.95	<b>NERL42-2P</b>	\$120
<b>NERL48 0648</b>	48" Blade (4 lbs.)	\$68.95	<b>NERL48-2P</b>	\$126



##### T-LUTE (ONE SIDE SMOOTH EDGE, ONE SIDE SERRATED TOOTHED EDGE)

<b>NERA24 0624T</b>	24" Blade (3 lbs.)	\$59.95	<b>NERA24-2P</b>	\$103
<b>NERA30 0630T</b>	30" Blade (3 lbs.)	\$61.95	<b>NERA30-2P</b>	\$109
<b>NERA36 0636T</b>	36" Blade (4 lbs.)	\$62.95	<b>NERA36-2P</b>	\$115
<b>NERA42 0642T</b>	42" Blade (4 lbs.)	\$71.95	<b>NERA42-2P</b>	\$131
<b>NERA48 0648T</b>	48" Blade (4 lbs.)	\$74.95	<b>NERA48-2P</b>	\$137



#### YANKEE® TRAP RAKES WITH SIFTING TEETH

<b>0510</b>	18" Blade (3 lbs.)	\$34.95
-------------	--------------------	---------

#### YANKEE® ROLLER SQUEEGEES WITH 48" GOLD ANODIZED HANDLES

##### NON-ABSORBANT (BLACK)

<b>** 0736</b>	36" Wide (6 lbs.)	\$107.50
<b>0748</b>	48" Replacement Roller (3 lbs.)	\$45.00

##### ABSORBANT (GREY)

<b>** 0724A</b>	24" Wide (6 lbs.)	\$104.50
<b>0736A</b>	36" Wide (6 lbs.)	\$114.50
<b>0748A</b>	48" Replacement Roller (3 lbs.)	\$50.00



#### YANKEE® LITTER PICK

<b>0450</b>	3/4" Tubular Handle with Pistol Grip, 41" Long	\$17.50
<b>0402</b>	Replacement Points for Above	\$5.95



**YOUR "ONE-STOP" SOURCE FOR AMERICA'S BASEBALL, SOFTBALL & SPORTS SURFACES & SUPPLIES!**

PRICES SUBJECT TO CHANGE & AVAILABILITY PLUS SHIPPING | VOLUME DISCOUNTS AVAILABLE | COOPERATIVE PURCHASING CONTRACT PRICING FOR 50 STATES

# BEAM CLAY®

**WHOLESALE PRICE LIST**  
EFFECTIVE: APRIL 23, 2021

## Midwest™ Rakes, Scarifier/Lutes & Roller Squeegees for Tennis Courts

### MIDWEST™ ALUMINUM RAKES

Light Yet Extra Heavy Duty with Strong, Wrap-Around, Solid Aluminum Braces for Maximum Head Stability and Long-Lasting Performance. 66" Powder Coated Aluminum Handles w/6" Vinyl Grips.

**PLEASE NOTE:** Midwest Plant will no longer drop ship. Check stock in NJ Warehouse.

**COURT RAKE** - Straight, Rounded Teeth with Extended Straight Edge Specifically Designed for Grading and Leveling.

- 12024** 24" Blade, 5 lbs.
- 12030** 30" Blade, 5 lbs.
- 12036** 36" Blade, 6 lbs.
- 12042** 42" Blade, 6 lbs.
- 12048** 48" Blade, 6 lbs.

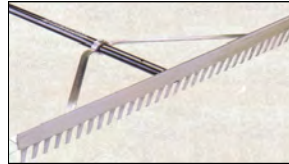

- \$64.95
- \$68.95
- \$70.95
- \$77.95
- \$82.95



**CHISEL-TOOTH RAKE** - Straight, Sharp, Extra Thick Chisel Teeth to Penetrate & Break Up Clay.

- 20024** 24" Blade, 5 lbs.
- 20030** 30" Blade, 5 lbs.
- 20036** 36" Blade, 6 lbs.
- 20042** 42" Blade, 6 lbs.
- 20048** 48" Blade, 6 lbs.
- 20060** 60" Blade, 8 lbs.

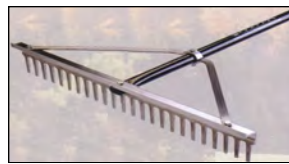

- \$69.95
- \$73.95
- \$78.95
- \$83.95
- \$88.95
- \$98.95

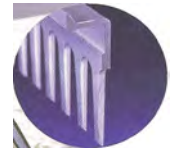

### MIDWEST™ SPECIALTY TOOLS

**TENNIS COURT SCARIFIER/LUTE** - One side serrated teeth, one side straight edge - Its saw-tooth design makes this tool an excellent choice when breaking up and grading hard clay. Originally designed for dressing clay tennis courts, the Scarifier Lute is also used by professional landscapers and grounds crews. Wrap-around bracing and a 1-1/8" diameter powder-coated aluminum handles with 5" vinyl grip provide maximum strength and comfort.

**Our Cost / List Larger Teeth, 66" Handle**

- 56923** 24" Blade \$52.95
- 56929** 30" Blade \$55.95
- 56935** 36" Blade \$58.95

**Finer Teeth**

- 52936** 36" Blade \$60.95

**82" Handle**

- 56924** 24" Blade \$57.95
- 56930** 30" Blade \$60.95
- 56936** 36" Blade \$64.95
- 52037** 36" Blade, \$66.95
- 52038** 36" Blade, 1-3/8" dia. handle \$67.95



### MIDWEST™ ROLLER SQUEEGEES

**ROLLER SQUEEGEE** - Called "The best roller squeegees on the market" by our customers, these roller squeegees are built to outlast and outperform other brands. These squeegees are excellent for rolling water off tennis courts. The heavy-duty aluminum frame construction and stainless steel axles ensure the roller stays secure. Two roller styles are available: Non-Absorbent—excellent for pushing water; and PVA Absorbent—made of superior high-tech polymer designed to soak up incredible amounts of liquid off hard surfaces. Rollers are easily replaceable and interchangeable.

#### Non-Absorbent Roller Squeegee

54" Powder Coated Curved Aluminum Handle With 6" Vinyl Grip.

- 70924** 24" Wide, 6 lbs. \$136.95
- 70936** 36" Wide, 8 lbs. \$155.95
- 70948** 48" Wide, 10 lbs. \$174.95

#### Replacement Rollers

- SA10047** 24" Non Absorbent, 2 lbs. \$56.95
- SA10048** 36" Non Absorbent, 3 lbs. \$70.95
- SA10049** 48" Non Absorbent, 4 lbs. \$84.95

#### PVA Absorbent

60" Powder Coated Aluminum Handle With Curved Aluminum Handle With 6" Vinyl Grip.

- 72036** 36" Wide, 7 lbs. \$158.95

#### Replacement Rollers

- SA10051** 36" PVA Absorbent, 3 lbs. \$75.95



**YOUR "ONE-STOP" SOURCE FOR AMERICA'S BASEBALL, SOFTBALL & SPORTS SURFACES & SUPPLIES!**

PRICES SUBJECT TO CHANGE & AVAILABILITY PLUS SHIPPING | VOLUME DISCOUNTS AVAILABLE | COOPERATIVE PURCHASING CONTRACT PRICING FOR 50 STATES

# BEAM CLAY®

## WHOLESALE PRICE LIST EFFECTIVE: APRIL 23, 2021

### Midwest™ Tennis Court Squeegees & Brooms

#### MIDWEST™ SQUEEGEES

**PLEASE NOTE:** Midwest Plant will no longer drop ship. Check stock in NJ Warehouse.

##### A. General Purpose Squeegee

The best on the market. Made with an extra-wide reversible neoprene rubber blade for long-lasting use. Available in 24" and 36" widths, this super flexible squeegee is excellent for pushing and pulling liquids off hard surfaces. Comes with a 66" powder-coated aluminum handle and wrap-around braces. Because the head bolts do not penetrate the rubber, the blade on this squeegee is easily reversible and replaceable.

- 76924** 24" Wide Blade, 5 lbs. **\$65.95**
- 76936** 36" Wide Blade, 6 lbs. **\$75.95**



##### B. Straight Blade Squeegee

A rugged squeegee, excellent for removing heavier liquids such as mud. The neoprene blade is stiffer than that used on the General Purpose Squeegee, so it scrapes as well as squeegees. Comes with a 66" powder-coated aluminum handle and wrap-around braces for maximum strength. The double-edge design doubles the life of the blade.

- 75936** 36" Wide Blade, 6 lbs. **\$71.95**



#### MIDWEST BROOMS

##### 7' WIDE MONSTER BROOM

Drag it on the infield, golf green, tennis or bocce court, push it on the warehouse floor. This broom is powerful and has amazing versatility. Made with heavy-duty aluminum construction. Available with two or three rows of 4-1/2" bristles. Bristles are removable for easy replacement or for adjusting the broom's stiffness.

- #82084** Monster Drag Broom (Two-Row Bristles) **\$198.95**
- #83084** Monster Drag Broom (Three-Row Bristles) **\$230.95**
- #SP50067** 7' Replacement Bristles (One Row) **\$42.95**



##### DOUBLE PLAY MONSTER BROOM

Identical to the two-row Monster Broom, the Double Play Monster Broom comes with an aggressive scarifying edge for breaking up packed soils.

- #82384** 84" Double Play Scarifier Monster Broom (Two-Row Bristles) **\$252.95**
- #SP50067** 7' Replacement Bristles (One Row) **\$42.95**

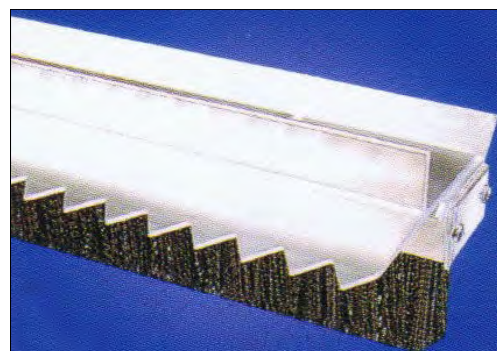

**YOUR "ONE-STOP" SOURCE FOR AMERICA'S BASEBALL, SOFTBALL & SPORTS SURFACES & SUPPLIES!**

PRICES SUBJECT TO CHANGE & AVAILABILITY PLUS SHIPPING | VOLUME DISCOUNTS AVAILABLE | COOPERATIVE PURCHASING CONTRACT PRICING FOR 50 STATES

# BEAM CLAY®

**WHOLESALE PRICE LIST**  
 EFFECTIVE: JANUARY 1, 2021

## Tennis Court Brooms

### **7' WIDE MAHOGANY TENNIS COURT BROOM** **WITH 3 ROWS OF 7" FIBER BRISTLES & 2 STEEL HANDLES**

This is the traditional court broom made the same way for over 75 years. The solid mahogany block is aesthetically pleasing and unaffected by water and severe temperature changes. Three full rows of 7" long bassine fiber absorb moisture and help dry the court. Two heavy gauge steel handles are included. The handles are reversible to prolong broom life. The broom provides an even sweep 7' wide.

#311-7



\$395

### **7' WIDE ALUMINUM TENNIS COURT BROOM** **WITH 3 ROWS OF 5-1/2" GREEN POLYPRO BRISTLES** **& TWO 4' ALUMINUM HANDLES WITH 20" CROSS PIECE**

This is the ultimate bocce court broom. The aluminum back brush is "dynamically weighted" to provide a one time pass 7' wide. It is the fullest brush on the market with 3 rows stiff polypropylene bristles 5.5" long epoxy set into the aluminum block. Bristles are inert to the elements. The broom is sold complete with two 4' aluminum handles joined by a 20" PVC cross piece. The handles are reversible for added broom life. The broom can be flipped over and used as a scraper. Two hooks are provided for hanging up.

#411-7



\$450

### **CART PULL MODEL**

This broom is designed to be pulled by a golf cart. The handle, with a hole to mount to a hitch pin, is at a right angle to pull the broom efficiently. Polypropylene fibers are durable and just the right stiffness to do a great job. The broom is also weighted to do the maximum amount of levelling without moving too much material.

#411T

\$395



**YOUR "ONE-STOP" SOURCE FOR AMERICA'S BASEBALL, SOFTBALL & SPORTS SURFACES & SUPPLIES!**

PRICES SUBJECT TO CHANGE & AVAILABILITY PLUS SHIPPING | VOLUME DISCOUNTS AVAILABLE | COOPERATIVE PURCHASING CONTRACT PRICING FOR 50 STATES

# BEAM CLAY®

Dri-Ball Drying Agent

**WHOLESALE PRICE LIST**  
 EFFECTIVE: JANUARY 1, 2021

**DRI-BALL®** Within 30 seconds turn any water-soaked ball into a perfectly dry ball! **DRI-BALL®** is quick and easy to use for games and practice! For baseball, softball, football, soccer, tennis, volleyball or any other sport with a ball that gets damp, wet or even soaking wet!

- Simply place the ball into an air-tight container with the **DRI-BALL®** compound.
- Shake the container - 30 seconds later, remove your ball and it will be completely dry and ready to use, and without any residue.
- **DRI-BALL®** also extends the life of balls, which reduces replacement costs.

One **DRI-BALL** kit contains 2 (1¼ lb.) packages of the **DRI-BALL** compound.

One to two kits should last one season, including practices:

#DB-KIT

\$75/Kit

- For baseball after wet practices, place 8-10 balls in 3-gallon container with 1 package of **DRI-BALL**. Shake for 30 seconds. All of the balls will be dry, will not rot, and will not get heavy. The entire kit should last for a 25-game season if you use **DRI-BALL** 2 to 3 days per week and keep **DRI-BALL** containers air-tight at all times.
- For football & soccer, dunk muddy balls into water to wash off mud. Place in 5-gallon container with 1 package of **DRI-BALL** and shake for 30 seconds. Your ball will be clean and dry! Nothing else is this easy! Keep **DRI-BALL** air-tight at all times.



**YOUR "ONE-STOP" SOURCE FOR AMERICA'S BASEBALL, SOFTBALL & SPORTS SURFACES & SUPPLIES!**

PRICES SUBJECT TO CHANGE & AVAILABILITY PLUS SHIPPING | VOLUME DISCOUNTS AVAILABLE | COOPERATIVE PURCHASING CONTRACT PRICING FOR 50 STATES

# BEAM CLAY®

Tennis Court Shoe Brushes

**WHOLESALE PRICE LIST**  
EFFECTIVE: JANUARY 1, 2021



## TENNIS COURT SHOE BRUSH

Two foam plastic blocks with blue plastic bristles on steel frame with steel scraper bar. Simple & Effective! (6 lbs.)

#4042414

\$69.95

#4042514 - Repl. Brush (two per Cleat Brush) each

\$12.95



## THE TREAD BLASTER

The Tread Blaster is uniquely designed to remove dirt and grit from your shoes without getting the tops of your shoes wet. A necessity for all facilities with clay courts. Easy to install, all you need is access to water and a hose with a spigot that provides a pressure of 30 to 60 psi. You'll be happy you made the investment.

147-4000

\$399

## TENNIE TWO-STEP

The Tennie Two-Step keeps carpets, players' shoes and walkways cleaner. The Tennie Two-Step is simplicity in itself. It is a UV-resistant polyethylene water-holding basin containing two patented perforated rubber panels designed to force water into the soles of your shoes while you rock back and forth on your feet. The results are noticeable everywhere. Clean shoes mean no more Fast-Dry in the house, on walkways, or in your car. Tennie Two-Step is available in its classic form, or with a newly designed shoe brush attached to the frame for more aggressive cleaning needs. You can also upgrade your existing units by installing a brush. Installation is simple and requires two holes to be drilled and two bolts to be tightened. All the appropriate hardware is included.



SHOTTSWB - Tennie Two-Step with Brush

\$220

SHOTTS - Tennie Two-Step (without Brush)

\$187

SHOTTSBR - Brush attachment

\$50



## COURT MAID

Court Maid's powder-coated, all-aluminum frame is designed to be installed at the entrance and exit points of your bocce court for cleaning shoes and trapping clay or Fast-Dry within its collection basin. The brush unit on top lifts off for easy removal of the accumulated Fast-Dry. Simply hose off to clean.

SHOCMJ - Black 14 3/4" x 20" x 4"

\$372.50



## HAR-TRU SHOE BRUSH

The Har-Tru "Scrusher" shoe brush can be attached to the sidewalk or left free standing. The softer upper bristles dust off the upper portion of the shoe while the stiffer lower bristles scrape topping from the soles. The base is made of heavy-duty carbon steel. The shoe brush is easily cleaned with a hose or soap and water.

SHOSBR

\$66.50

SHOSBRBB Replacement Bottom Brush

\$7.95

SHOSBRBS Replacement Side Brush (each)

\$20.99

**YOUR "ONE-STOP" SOURCE FOR AMERICA'S BASEBALL, SOFTBALL & SPORTS SURFACES & SUPPLIES!**

PRICES SUBJECT TO CHANGE & AVAILABILITY PLUS SHIPPING | VOLUME DISCOUNTS AVAILABLE | COOPERATIVE PURCHASING CONTRACT PRICING FOR 50 STATES



Synthetic Turf for Tennis Courts

**WHOLESALE PRICE LIST**  
 EFFECTIVE: JANUARY 1, 2021

## TENNIS TURF™ - SYNTHETIC TURF FOR TENNIS COURTS

A perfect tennis court needs to perform authentically and consistently—our turf does just that. Tennis turf is designed to act like natural grass, reducing the risk of injury to your joints and giving you a fun, reliable court.

Can be installed over crushed aggregate base (3/4" minus) or glued to concrete or asphalt. Tape and glue needed for seams, if installing over crushed aggregate. 1/2" of fine stone dust recommended over crushed aggregate base for a smooth compacted surface. Perforated turf not recommended—can cause wash out in base. Perimeter drainage best.

<b>24 oz. Polypropylene</b> , 12' wide, pine green or clay SilverBack™ Polyurethane	<b>PL35712WSB</b>	<b>\$2.10/sf</b>
<b>36 oz. POLYPROPYLENE</b> artificial turf. Available in 14 colors.		
12' wide, pine or spring green, SilverBack™ Polyurethane	<b>PL70512WSB</b>	<b>\$2.75/sf</b>
15' wide, pine or spring green, SilverBack™ Polyurethane	<b>PL70515WSB</b>	<b>\$2.75/sf</b>
15' wide, spring green, 1mm rubber	<b>PL70515W1MM</b>	<b>\$3.25/sf</b>
12' wide, clay, red, white, blue, orange, yellow, black, purple, crimson, maroon, brown, navy, SilverBack™ Polyurethane	<b>PL12WCSb</b>	<b>\$2.95/sf</b>

**PLEASE NOTE:** Synthetic Turf is normally rolled face out. No charge to “reverse roll” cut pieces with turf faced in—which makes it easier to install—doesn’t need to be flipped over.

There is a **\$50 charge per piece to cut the width** (there is a 1/4" tolerance) and/or pre-trim the scrim fabric along edge and reverse roll so that each piece will unroll with turf side up. For full rolls, there is a \$50 charge for pre-trimming & reverse rolling.

1 mm rubber backing does not expand or contract as much as other backings and is especially used for loose lay applications.

Scrim on foam backing keeps the foam from cracking when stored rolled up in warehouse.

Scrim will not curl if gluing down but will curl if installing over crushed aggregate without securing the perimeter.

Use foam back with scrim for gluing to concrete or asphalt. Use foam without scrim for installing over crushed aggregate unless securing perimeter.

If gluing unitary backing, be sure glue is polyurethane compatible.

Robert’s 6700, TurfClaw and NORDOT 34-G are polyurethane compatible but always double check the label to be sure.

**YOUR “ONE-STOP” SOURCE FOR AMERICA’S BASEBALL, SOFTBALL & SPORTS SURFACES & SUPPLIES!**

PRICES SUBJECT TO CHANGE & AVAILABILITY PLUS SHIPPING | VOLUME DISCOUNTS AVAILABLE | COOPERATIVE PURCHASING CONTRACT PRICING FOR 50 STATES



**BEAM CLAY®**

Synthetic Turf for Tennis Courts

**WHOLESALE PRICE LIST**

# TENNIS TURF



## TENNIS TURF 24 oz. POLY

### PRODUCT DATA SHEET

<b>Yarn Type:</b>	24 oz. Polypropylene Pile
<b>Secondary Backing:</b>	5mm Foam, 3mm Foam, or SilverBack™ Polyurethane
<b>Pile Height:</b>	1/4" (+/- 1/8"), overall height with foam approx. 1/2"
<b>Roll Width:</b>	12' Untrimmed
<b>Perforated:</b>	No
<b>Color:</b>	Pine
<b>Shipping Weight:</b>	47 oz., per square yard with SilverBack™ Polyurethane
<b>Infill:</b>	No infill

**Applications:**

This product performs well as a tennis court surface. Infill is not required. This product can be installed outdoors on concrete, asphalt, or a compacted aggregate base or indoors on concrete.

These specifications are standard and may vary slightly due to manufacturing tolerances.

**YOUR "ONE-STOP" SOURCE FOR AMERICA'S BASEBALL, SOFTBALL & SPORTS SURFACES & SUPPLIES!**

PRICES SUBJECT TO CHANGE & AVAILABILITY PLUS SHIPPING | VOLUME DISCOUNTS AVAILABLE | COOPERATIVE PURCHASING CONTRACT PRICING FOR 50 STATES

**PARTAC PEAT CORPORATION**  
ONE KELSEY PARK, GREAT MEADOWS, NEW JERSEY 07838

800-247-BEAM (2326) • (908) 637-4191 • FAX (908) 637-8421  
www.beamclay.com • sales@beamclay.com  
Bid Term - 5/9/18 - 5/8/20; Extended to 5/8/21; Extended to 5/8/22

# TENNIS TURF

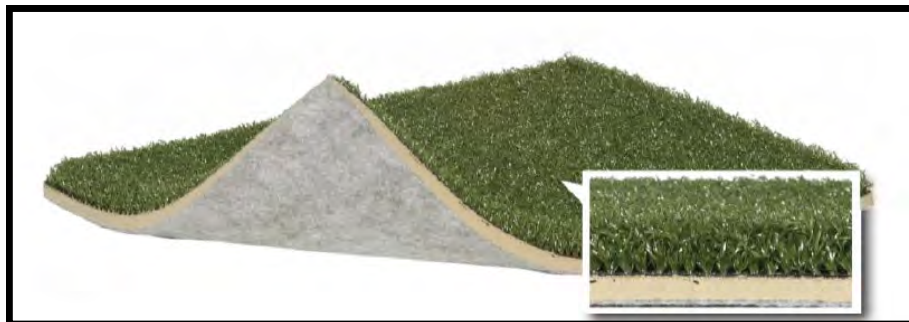

## TENNIS 36 oz. POLYPROPYLENE PRODUCT DATA SHEET

<b>Yarn Type:</b>	36 oz. Polypropylene Pile
<b>Pile Height:</b>	9/16" (+/- 1/8")
<b>Roll Width:</b>	12' Untrimmed
<b>Perforated:</b>	No
<b>Color:</b>	Pine or Clay
<b>Shipping Weight:</b>	63 oz per sq yard (with SilverBack™ Polyurethane)
<b>Infill:</b>	No infill
<b>Applications:</b>	Performs well as a tennis court surface. No infill required. Can be installed outdoors on concrete, asphalt, or a compacted aggregate base or indoors on concrete.

.These specifications are standard and may vary slightly due to manufacturing tolerances.



**YOUR "ONE-STOP" SOURCE FOR AMERICA'S BASEBALL, SOFTBALL & SPORTS SURFACES & SUPPLIES!**

*PRICES SUBJECT TO CHANGE & AVAILABILITY PLUS SHIPPING | VOLUME DISCOUNTS AVAILABLE | COOPERATIVE PURCHASING CONTRACT PRICING FOR 50 STATES*

**Partac Peat Corporation – Item Price Schedule**  
**Athletic Equipment & Supplies BID# ESCNJ 17/18-31 Effective 5/9/2018 - 5/8/2022**

Bidding Company Name:				Partac Peat Corporation		Catalog Name:		8A - Tennis Court Surfaces, Equipment and Supplies					
No.	Product Category	Beam Clay Catalog Section #	Page#	Product Description	Manufacturer	Vendor SKU	Unit of Measure	Catalog List Price	Bid Discount Percentage	Discount Amt.	Net Effective Bid Price	Comments	No.
1	Tennis	8A	3	Tennis Court Clay - Red (Extra Firm) - Bulk - F.O.B. NJ	Partac Peat Corporation	TC-RXF-BULK	TON	\$ 135.000	5.0%	\$ 6.750	\$ 128.250	+ shipping - see freight notes	1
2	Tennis	8A	3	Tennis Court Clay - Red (Extra Firm) up to 50 (50 lb. bags)/pallet - F.O.B. NJ	Partac Peat Corporation	TC-RXF-BAG	50 LB BAG	\$ 10.500	5.0%	\$ 0.525	\$ 9.975	+ shipping - see freight notes	2
3	Tennis	8A	3	Tennis Court Clay - Orange (Extra Firm) - Bulk - F.O.B. NJ	Partac Peat Corporation	TC-OXF-BULK	TON	\$ 125.000	5.0%	\$ 6.250	\$ 118.750	+ shipping - see freight notes	3
4	Tennis	8A	3	Tennis Court Clay - Orange (Extra Firm) up to 50 (50 lb. bags)/pallet - F.O.B. NJ	Partac Peat Corporation	TC-OXF-BAG	50 LB BAG	\$ 9.500	5.0%	\$ 0.475	\$ 9.025	+ shipping - see freight notes	4
5	Tennis	8A	3	Tennis Court Clay - Brown (Extra Firm) - Bulk - F.O.B. NJ	Partac Peat Corporation	TC-BXF-BULK	TON	\$ 125.000	5.0%	\$ 6.250	\$ 118.750	+ shipping - see freight notes	5
6	Tennis	8A	3	Tennis Court Clay - Brown (Extra Firm) up to 50(50 lb. bags)/pallet - F.O.B. NJ	Partac Peat Corporation	TC-BXF-BAG	50 LB BAG	\$ 9.500	5.0%	\$ 0.475	\$ 9.025	+ shipping - see freight notes	6
7	Tennis	8A	3	Tennis Court Clay - Grey (Medium Firm) - Bulk - F.O.B. NJ	Partac Peat Corporation	TC-GMF-BULK	TON	\$ 115.000	5.0%	\$ 5.750	\$ 109.250	+ shipping - see freight notes	7
8	Tennis	8A	3	Tennis Court Clay - Grey (Medium Firm) up to 50(50 lb. bags)/pallet - F.O.B. NJ	Partac Peat Corporation	TC-GMF-BAG	50 LB BAG	\$ 7.500	5.0%	\$ 0.375	\$ 7.125	+ shipping - see freight notes	8
9	Tennis	8A	3	Tennis Court Clay - Tan (Medium Firm) - Bulk - F.O.B. NJ	Partac Peat Corporation	TC-TMF-BULK	TON	\$ 115.000	5.0%	\$ 5.750	\$ 109.250	+ shipping - see freight notes	9
10	Tennis	8A	3	Tennis Court Clay - Tan (Medium Firm) up to 50(50 lb. bags)/pallet - F.O.B. NJ	Partac Peat Corporation	TC-TMF-BAG	50 LB BAG	\$ 7.500	5.0%	\$ 0.375	\$ 7.125	+ shipping - see freight notes	10
11	Tennis	8A	3	Tennis Court Clay - Orange (Medium Firm) - Bulk - F.O.B. NJ	Partac Peat Corporation	TC-OMF-BULK	TON	\$ 125.000	5.0%	\$ 6.250	\$ 118.750	+ shipping - see freight notes	11
12	Tennis	8A	3	Tennis Court Clay - Orange (Medium Firm) up to 50(50 lb. bags)/pallet - F.O.B. NJ	Partac Peat Corporation	TC-OMF-BAG	50 LB BAG	\$ 9.500	5.0%	\$ 0.475	\$ 9.025	+ shipping - see freight notes	12
13	Tennis	8A	3	Red Slate Top-Dressing - Bulk	Regional Plant	RSTD-BULK	TON	\$ 125.000	5.0%	\$ 6.250	\$ 118.750	+ shipping - see freight notes	13
14	Tennis	8A	3	Red Slate Top-Dressing up to 50 (50 lb.) bags/pallet - F.O.B. NJ	Regional Plant	RSTD-BAG	50 LB BAG	\$ 8.750	5.0%	\$ 0.438	\$ 8.313	+ shipping - see freight notes	14
15	Tennis	8A	3	Red Brick Dust Top-Dressing - Bulk - F.O.B. NJ	Regional Plant	RDBD-BULK	TON	\$ 165.000	5.0%	\$ 8.250	\$ 156.750	+ shipping - see freight notes	15
16	Tennis	8A	3	Red Brick Dust Top-Dressing 50 (50 lb.) bags/pallet - F.O.B. NJ	Regional Plant	RDBD-BAG	50 LB BAG	\$ 8.950	5.0%	\$ 0.448	\$ 8.503	+ shipping - see freight notes	16
17	Tennis	8A	3	Magnesium Chloride Flakes 50 (50 lb. bags)/pallet - F.O.B. NJ	Schoenburg	MAG-FLAKES	50 LB BAG	\$ 22.950	5.0%	\$ 1.148	\$ 21.803	+ shipping - see freight notes	17
18	Tennis	8A	3	Magnesium Chloride Pellets 48 (50 lb. bags)/pallet - F.O.B. NJ	Schoenburg	MAG-PELLETS	50 LB BAG	\$ 31.950	5.0%	\$ 1.598	\$ 30.353	+ shipping - see freight notes	18
19	Tennis	8A	3	Calcium Chloride Flakes 55 (50 lb. bags)/pallet - F.O.B. NJ	Schoenburg	CC-FLAKES	50 LB BAG	\$ 20.950	5.0%	\$ 1.048	\$ 19.903	+ shipping - see freight notes	19
20	Tennis	8A	3	Calcium Chloride Pellets 55 (50 lb. bags)/pallet - F.O.B. NJ	Schoenburg	CC-PELLETS	50 LB BAG	\$ 22.950	5.0%	\$ 1.148	\$ 21.803	+ shipping - see freight notes	20
21	Tennis	8A	3	FULL OR PARTIAL PALLETS: PALLET & COVER CHARGES FROM NJ	Partac Peat Corporation	NJ-PALLET	EACH	\$ 6.500	5.0%	\$ 0.325	\$ 6.175	+ shipping - see freight notes	21
22	Tennis	8A	3	MIDWEST & SOUTH NATURAL TENNIS COURT CLAY - Extra Firm Red, One Ton Bulk Bags F.O.B. Regional Plant	Regional Plant	MW-XFR-BB	2,000 LB. BAG	\$ 595.000	5.0%	\$ 29.750	\$ 565.250	+ shipping - see freight notes	22
23	Tennis	8A	3	MIDWEST & SOUTH NATURAL TENNIS COURT CLAY - Extra Firm Red, Bulk F.O.B. Regional Plant	Regional Plant	MW-XFR-BULK	TON	\$ 80.000	5.0%	\$ 4.000	\$ 76.000	+ shipping - see freight notes	23
24	Tennis	8A	3	WEST COAST NATURAL TENNIS COURT CLAY - Extra Firm Red Bulk F.O.B. Regional Plant	Regional Plant	WC-XFR-BULK	TON	\$ 175.000	5.0%	\$ 8.750	\$ 166.250	+ shipping - see freight notes	24
25	Tennis	8A	3	WEST COAST NATURAL TENNIS COURT CLAY - Extra Firm Red One Ton Bulk Bags, F.O.B. Regional Plant	Regional Plant	WC-XFR-BB	2,000 BAG	\$ 265.000	5.0%	\$ 13.250	\$ 251.750	+ shipping - see freight notes	25
26	Tennis	8A	3	RED LAVA DUST TOP-DRESSING - 1.5 CY bulk bags - F.O.B. Regional Plant	Regional Plant	LAVADUST-CYB	1.5 CY BAG	\$ 245.000	5.0%	\$ 12.250	\$ 232.750	+ shipping - see freight notes	26
27	Tennis	8A	3	POLYMERIZED CLAY - Extra Firm Red/Brown, up to 40 (50 lb.) bags/pallet - F.O.B. AZ	Stabilizer	HT-AZ-BAG	50 LB BAG	\$ 18.500	5.0%	\$ 0.925	\$ 17.575	+ shipping - see freight notes	27
28	Tennis	8A	3	POLYMERIZED CLAY - Extra Firm Red/Brown, up to 40 (50 lb.) bags/pallet - F.O.B. NJ	Stabilizer	HT-NJ-BAG	50 LB BAG	\$ 28.500	5.0%	\$ 1.425	\$ 27.075	+ shipping - see freight notes	28
29	Tennis	8A	3	POLYMERIZED TOP-DRESSING, one-ton bulk bag F.O.B. AZ	Stabilizer	HT-TD-AZ-BB	2000 LB BAG	\$ 365.000	5.0%	\$ 18.250	\$ 346.750	+ shipping - see freight notes	29
30	Tennis	8A	3	POLYMERIZED TOP-DRESSING, one-ton bulk bag F.O.B. NJ	Stabilizer	HT-TD-NJ-BB	2000 LB BAG	\$ 725.000	5.0%	\$ 36.250	\$ 688.750	+ shipping - see freight notes	30
31	Tennis	8A	3	NORTHEAST - Green 35 (80 lb. bags)/pallet - F.O.B. NJ	Hadeka	NE-G80-NJ	80 LB BAG	\$ 9.750	5.0%	\$ 0.488	\$ 9.263	+ shipping - see freight notes	31
32	Tennis	8A	3	NORTHEAST - Green 35 (80 lb. bags)/pallet - F.O.B. VT - Full Pallets Only	Hadeka	NE-G80-VT	80 LB BAG	\$ 6.950	5.0%	\$ 0.348	\$ 6.603	+ shipping - see freight notes	32

Bidding Company Name:				Partac Peat Corporation		Catalog Name:		8A - Tennis Court Surfaces, Equipment and Supplies						
No.	Product Category	Beam Clay Catalog Section #	Page#	Product Description	Manufacturer	Vendor SKU	Unit of Measure	Catalog List Price	Bid Discount Percentage	Discount Amt.	Net Effective Bid Price	Comments	No.	
33	Tennis	8A	3	NORTHEAST - Green 48 (50 lb. bags)/pallet - F.O.B. NJ	Hadeka	NE-G50-NJ	50 LB BAG	\$ 6.500	5.0%	\$ 0.325	\$ 6.175	+ shipping - see freight notes	33	
34	Tennis	8A	3	NORTHEAST - Green 48 (50 lb. bags)/pallet - F.O.B. VT - Full Pallets Only	Hadeka	NE-G50-VT	50 LB BAG	\$ 4.750	5.0%	\$ 0.238	\$ 4.513	+ shipping - see freight notes	34	
35	Tennis	8A	3	NORTHEAST - Green 2,000 lb. Bulk Bags - F.O.B. NJ	Hadeka	NE-GBB-NJ	2000 LB BAG	\$ 265.000	5.0%	\$ 13.250	\$ 251.750	+ shipping - see freight notes	35	Price Decrease
36	Tennis	8A	3	NORTHEAST - Green 2,000 lb. Bulk Bags - F.O.B. VT - Full Pallets Only	Hadeka	NE-GBB-VT	2000 LB BAG	\$ 195.000	5.0%	\$ 9.750	\$ 185.250	+ shipping - see freight notes	36	
37	Tennis	8A	3	NORTHEAST - Red 35 (80 lb. bags)/pallet - F.O.B. NJ	Hadeka	NE-R80-NJ	80 LB BAG	\$ 12.050	5.0%	\$ 0.603	\$ 11.448	+ shipping - see freight notes	37	
38	Tennis	8A	3	NORTHEAST - Red 35 (80 lb. bags)/pallet - F.O.B. VT - Full Pallets Only	Hadeka	NE-R80-VT	80 LB BAG	\$ 9.250	5.0%	\$ 0.463	\$ 8.788	+ shipping - see freight notes	38	
39	Tennis	8A	3	NORTHEAST - Red 2,000 lb. Bulk Bag - F.O.B. NJ	Hadeka	NE-RBB-NJ	2000 LB BAG	\$ 315.000	5.0%	\$ 15.750	\$ 299.250	+ shipping - see freight notes	39	Price Decrease
40	Tennis	8A	3	NORTHEAST - Red 2,000 lb. Bulk Bag - F.O.B. VT - Full Pallets Only	Hadeka	NE-RBB-VT	2000 LB BAG	\$ 245.000	5.0%	\$ 12.250	\$ 232.750	+ shipping - see freight notes	40	
41	Tennis	8A	3	Magnesium Chloride Flakes 48 (50 lb. bags)/pallet - F.O.B. VT - Full Pallets Only	Hadeka	NE-MAGFLK-VT	50 LB BAG	\$ 19.500	5.0%	\$ 0.975	\$ 18.525	+ shipping - see freight notes	41	Price Decrease
42	Tennis	8A	4	Har-Tru Surfacing - 1.4 TON (80 LB. BAGS—35/PALLET), F.O.B. VA - Full Pallets Only	Hartru	TCMHT8014-VA	80 LB BAG	\$ 9.500	5.0%	\$ 0.475	\$ 9.025	+ shipping - see freight notes	42	Price Decrease
43	Tennis	8A	4	Har-Tru Surfacing - 1.4 TON (80 LB. BAGS—35/PALLET), F.O.B. NJ	Hartru	TCMHT8014-NJ	80 LB BAG	\$ 13.450	5.0%	\$ 0.673	\$ 12.778	+ shipping - see freight notes	43	
44	Tennis	8A	4	Har-Tru Surfacing - 1 TON (80 LB. BAGS—25/PALLET), F.O.B. VA - Full Pallets Only	Hartru	TCMHT8010-VA	80 LB BAG	\$ 9.780	5.0%	\$ 0.489	\$ 9.291	+ shipping - see freight notes	44	
45	Tennis	8A	4	Har-Tru Surfacing - 1 TON (80 LB. BAGS—25/PALLET), F.O.B. NJ	Hartru	TCMHT8010-NJ	80 LB BAG	\$ 13.850	5.0%	\$ 0.693	\$ 13.158	+ shipping - see freight notes	45	
46	Tennis	8A	4	Har-Tru Surfacing - 1.4 TON (50 LB. BAGS—56/PALLET), F.O.B. VA - Full Pallets Only	Hartru	TCMHT5014-VA	50 LB BAG	\$ 6.440	5.0%	\$ 0.322	\$ 6.118	+ shipping - see freight notes	46	
47	Tennis	8A	4	Har-Tru Surfacing - 1.4 TON (50 LB. BAGS—56/PALLET), F.O.B. NJ	Hartru	TCMHT5014-NJ	50 LB BAG	\$ 8.950	5.0%	\$ 0.448	\$ 8.503	+ shipping - see freight notes	47	
48	Tennis	8A	4	Har-Tru Surfacing - 1 TON (50 LB. BAGS—40/PALLET), F.O.B. VA - Full Pallets Only	Hartru	TCMHT5010-VA	50 LB BAG	\$ 6.830	5.0%	\$ 0.342	\$ 6.489	+ shipping - see freight notes	48	
49	Tennis	8A	4	Har-Tru Surfacing - 1 TON (50 LB. BAGS—40/PALLET), F.O.B. NJ	Hartru	TCMHT5010-NJ	50 LB BAG	\$ 9.350	5.0%	\$ 0.468	\$ 8.883	+ shipping - see freight notes	49	
50	Tennis	8A	4	Har-Tru Surfacing - 2,000 LB. BULK BAG, F.O.B. VA - Full Pallets Only	Hartru	TCMHT2000-VA	2000 LB BAG	\$ 279.850	5.0%	\$ 13.993	\$ 265.858	+ shipping - see freight notes	50	
51	Tennis	8A	4	Har-Tru Surfacing - 2,000 LB. BULK BAG, F.O.B. NJ	Hartru	TCMHT2000-NJ	2000 LB BAG	\$ 385.000	5.0%	\$ 19.250	\$ 365.750	+ shipping - see freight notes	51	
52	Tennis	8A	4	Har-Tru Surfacing - 2,500 LB. BULK BAG, F.O.B. VA - Full Pallets Only	Hartru	TCMHT2500-VA	2500 LB BAG	\$ 332.050	5.0%	\$ 16.603	\$ 315.448	+ shipping - see freight notes	52	
53	Tennis	8A	4	Har-Tru Surfacing - 2,500 LB. BULK BAG, F.O.B. NJ	Hartru	TCMHT2500-NJ	2500 LB BAG	\$ 455.000	5.0%	\$ 22.750	\$ 432.250	+ shipping - see freight notes	53	
54	Tennis	8A	4	Har-Tru Surfacing - 2,800 LB. BULK BAG, F.O.B. VA - Full Pallets Only	Hartru	TCMHT2800-VA	2800 LB BAG	\$ 353.800	5.0%	\$ 17.690	\$ 336.110	+ shipping - see freight notes	54	
55	Tennis	8A	4	Har-Tru Surfacing - 2,800 LB. BULK BAG, F.O.B. NJ	Hartru	TCMHT2800-NJ	2800 LB BAG	\$ 495.000	5.0%	\$ 24.750	\$ 470.250	+ shipping - see freight notes	55	
56	Tennis	8A	4	HydroBlend For Sub-Irrigated Tennis Courts - 1.4 TON (80 LB. BAGS—35/PALLET), F.O.B. VA - Full Pallets Only	Hartru	TCMHB8014-VA	80 LB BAG	\$ 8.900	5.0%	\$ 0.445	\$ 8.455	+ shipping - see freight notes	56	
57	Tennis	8A	4	HydroBlend For Sub-Irrigated Tennis Courts - 1.4 TON (80 LB. BAGS—35/PALLET), F.O.B. NJ	Hartru	TCMHB8014-NJ	80 LB BAG	\$ 12.850	5.0%	\$ 0.643	\$ 12.208	+ shipping - see freight notes	57	
58	Tennis	8A	4	HydroBlend For Sub-Irrigated Tennis Courts - 1 TON (80 LB. BAGS—25/PALLET), F.O.B. VA - Full Pallets Only	Hartru	TCMHB8010-VA	80 LB BAG	\$ 9.220	5.0%	\$ 0.461	\$ 8.759	+ shipping - see freight notes	58	
59	Tennis	8A	4	HydroBlend For Sub-Irrigated Tennis Courts - 1 TON (80 LB. BAGS—25/PALLET), F.O.B. NJ	Hartru	TCMHB8010-NJ	80 LB BAG	\$ 13.250	5.0%	\$ 0.663	\$ 12.588	+ shipping - see freight notes	59	
60	Tennis	8A	4	HydroBlend For Sub-Irrigated Tennis Courts - 1.4 TON (50 LB. BAGS—56/PALLET), F.O.B. VA - Full Pallets Only	Hartru	TCMHB5014-VA	50 LB BAG	\$ 6.200	5.0%	\$ 0.310	\$ 5.890	+ shipping - see freight notes	60	
61	Tennis	8A	4	HydroBlend For Sub-Irrigated Tennis Courts - 1.4 TON (50 LB. BAGS—56/PALLET), F.O.B. NJ	Hartru	TCMHB5014-NJ	50 LB BAG	\$ 8.750	5.0%	\$ 0.438	\$ 8.313	+ shipping - see freight notes	61	
62	Tennis	8A	4	HydroBlend For Sub-Irrigated Tennis Courts - 1 TON (50 LB. BAGS—40/PALLET), F.O.B. VA - Full Pallets Only	Hartru	TCMHB5010-VA	50 LB BAG	\$ 6.550	5.0%	\$ 0.328	\$ 6.223	+ shipping - see freight notes	62	
63	Tennis	8A	4	HydroBlend For Sub-Irrigated Tennis Courts - 1 TON (50 LB. BAGS—40/PALLET), F.O.B. NJ	Hartru	TCMHB5010-NJ	50 LB BAG	\$ 9.150	5.0%	\$ 0.458	\$ 8.693	+ shipping - see freight notes	63	
64	Tennis	8A	4	HydroBlend For Sub-Irrigated Tennis Courts - 2,000 LB. BULK BAG, F.O.B. VA - Full Pallets Only	Hartru	TCMHB2000-VA	2000 LB BAG	\$ 266.800	5.0%	\$ 13.340	\$ 253.460	+ shipping - see freight notes	64	
65	Tennis	8A	4	HydroBlend For Sub-Irrigated Tennis Courts - 2,000 LB. BULK BAG, F.O.B. NJ	Hartru	TCMHB2000-NJ	2000 LB BAG	\$ 375.000	5.0%	\$ 18.750	\$ 356.250	+ shipping - see freight notes	65	

Bidding Company Name:				Partac Peat Corporation		Catalog Name:		8A - Tennis Court Surfaces, Equipment and Supplies						
No.	Product Category	Beam Clay Catalog Section #	Page#	Product Description	Manufacturer	Vendor SKU	Unit of Measure	Catalog List Price	Bid Discount Percentage	Discount Amt.	Net Effective Bid Price	Comments	No.	
66	Tennis	8A	4	HydroBlend For Sub-Irrigated Tennis Courts - 2,500 LB. BULK BAG, F.O.B. VA - Full Pallets Only	Hartru	TCMH2500-VA	2500 LB BAG	\$ 304.500	5.0%	\$ 15.225	\$ 289.275	+ shipping - see freight notes	66	
67	Tennis	8A	4	HydroBlend For Sub-Irrigated Tennis Courts - 2,500 LB. BULK BAG, F.O.B. NJ	Hartru	TCMH2500-NJ	2500 LB BAG	\$ 435.000	5.0%	\$ 21.750	\$ 413.250	+ shipping - see freight notes	67	
68	Tennis	8A	4	HydroBlend For Sub-Irrigated Tennis Courts - 2,800 LB. BULK BAG, F.O.B. VA - Full Pallets Only	Hartru	TCMH2800-VA	2800 LB BAG	\$ 343.650	5.0%	\$ 17.183	\$ 326.468	+ shipping - see freight notes	68	
69	Tennis	8A	4	HydroBlend For Sub-Irrigated Tennis Courts - 2,800 LB. BULK BAG, F.O.B. NJ	Hartru	TCMH2800-NJ	2800 LB BAG	\$ 485.000	5.0%	\$ 24.250	\$ 460.750	+ shipping - see freight notes	69	
70	Tennis	8A	4	Coarse Blend For Sub-Irrigated Tennis Courts - 1.3 TON (75 LB. BAGS—35/PALLET), F.O.B. VA - Full Pallets Only	Hartru	TCMCB7513-VA	75 LB BAG	\$ 10.150	5.0%	\$ 0.508	\$ 9.643	+ shipping - see freight notes	70	
71	Tennis	8A	4	Coarse Blend For Sub-Irrigated Tennis Courts - 1.3 TON (75 LB. BAGS—35/PALLET), F.O.B. NJ	Hartru	TCMCB7513-NJ	75 LB BAG	\$ 13.950	5.0%	\$ 0.698	\$ 13.253	+ shipping - see freight notes	71	
72	Tennis	8A	4	American Red For Sub-Irrigated Tennis Courts - AMERICAN RED / 1.4 TON (70 LB. BAGS—40/PALLET), F.O.B. VA - Full Pallets Only	Hartru	TCMAR7014-VA	70 LB BAG	\$ 13.000	5.0%	\$ 0.650	\$ 12.350	+ shipping - see freight notes	72	
73	Tennis	8A	4	American Red For Sub-Irrigated Tennis Courts - AMERICAN RED / 1.4 TON (70 LB. BAGS—40/PALLET), F.O.B. NJ	Hartru	TCMAR7014-NJ	70 LB BAG	\$ 17.950	5.0%	\$ 0.898	\$ 17.053	+ shipping - see freight notes	73	Price Decrease
74	Tennis	8A	4	American Red For Sub-Irrigated Tennis Courts - AMERICAN RED (2,000 LB. BAG), F.O.B. VA - Full Pallets Only	Hartru	TCMAR2000-VA	2000 LB BAG	\$ 440.800	5.0%	\$ 22.040	\$ 418.760	+ shipping - see freight notes	74	
75	Tennis	8A	4	American Red For Sub-Irrigated Tennis Courts - AMERICAN RED (2,000 LB. BAG), F.O.B. NJ	Hartru	TCMAR2000-NJ	2000 LB BAG	\$ 545.000	5.0%	\$ 27.250	\$ 517.750	+ shipping - see freight notes	75	
76	Tennis	8A	4	EUROPEAN RED CLAY (55 LB. BAGS), F.O.B. VA - Full Pallets Only	Hartru	EURORED-VA	55 LB BAG	\$ 38.250	5.0%	\$ 1.913	\$ 36.338	+ shipping - see freight notes	76	
77	Tennis	8A	4	Calcium Chloride Flakes (55 LB. BAGS—up to 48/pallet) - CALCIUM CHLORIDE WITH TRUCK LOAD, F.O.B. VA - Full Pallets Only	Hartru	SOLCALTCM-VA	55 LB BAG	\$ 25.000	5.0%	\$ 1.250	\$ 23.750	+ shipping - see freight notes	77	
78	Tennis	8A	4	Magnesium Chloride Flakes (55 LB. BAGS—up to 48/pallet) - MAGNESIUM CHLORIDE WITH TRUCK LOAD, F.O.B. VA - Full Pallets Only	Hartru	SOLMAGTCM-VA	55 LB BAG	\$ 25.000	5.0%	\$ 1.250	\$ 23.750	+ shipping - see freight notes	78	
79	Tennis	8A	4	RAIN COVER SHROUD TO COVER PALLET - #PLSSH	Hartru	PLSSH	EACH	\$ 6.000	5.0%	\$ 0.300	\$ 5.700	+ shipping - see freight notes	79	
80	Tennis	8A	various	FULL OR PARTIAL PALLETS: PALLET & COVER CHARGES FROM NJ	Partac Peat Corporation	NJ-PALLET	EACH	\$ 6.500	5.0%	\$ 0.325	\$ 6.175	+ shipping - see freight notes	80	
81	Tennis	8A	13	RIGID INFIELD DRAG MATS - HEAVY DUTY 3' Wide x 3 1/2' Long #RIDM3x3-1/2	Partac Peat Corp.	#RIDM3x3-1/2	EACH	\$ 175.00	5.0%	\$ 8.750	\$ 166.250	+ shipping - see freight notes	81	
82	Tennis	8A	13	RIGID INFIELD DRAG MATS - HEAVY DUTY 4' Wide x 3 1/2' Long #RIDM4x3-1/2	Partac Peat Corp.	#RIDM4x3-1/2	EACH	\$ 205.00	5.0%	\$ 10.250	\$ 194.750	+ shipping - see freight notes	82	
83	Tennis	8A	13	RIGID INFIELD DRAG MATS - HEAVY DUTY 5' Wide x 3 1/2' Long #RIDM5x3-1/2	Partac Peat Corp.	#RIDM5x3-1/2	EACH	\$ 245.00	5.0%	\$ 12.250	\$ 232.750	+ shipping - see freight notes	83	
84	Tennis	8A	13	RIGID INFIELD DRAG MATS - HEAVY DUTY 6' Wide x 3 1/2' Long #RIDM6x3-1/2	Partac Peat Corp.	#RIDM6x3-1/2	EACH	\$ 295.00	5.0%	\$ 14.750	\$ 280.250	+ shipping - see freight notes	84	
85	Tennis	8A	13	RIGID INFIELD DRAG MATS - HEAVY DUTY 4' Wide x 18" Long #RIDM4x18	Partac Peat Corp.	#RIDM4x18	EACH	\$ 105.00	5.0%	\$ 5.250	\$ 99.750	+ shipping - see freight notes	85	
86	Tennis	8A	13	RIGID INFIELD DRAG MATS - HEAVY DUTY 4' Wide x 2' Long #RIDM4x2	Partac Peat Corp.	#RIDM4x2	EACH	\$ 125.00	5.0%	\$ 6.250	\$ 118.750	+ shipping - see freight notes	86	
87	Tennis	8A	13	RIGID INFIELD DRAG MATS - HEAVY DUTY 4' Wide x 3' Long #RIDM4x3	Partac Peat Corp.	#RIDM4x3	EACH	\$ 145.00	5.0%	\$ 7.250	\$ 137.750	+ shipping - see freight notes	87	
88	Tennis	8A	13	RIGID INFIELD DRAG MATS - HEAVY DUTY 6' Wide x 18" Long #RIDM6x18	Partac Peat Corp.	#RIDM6x18	EACH	\$ 145.00	5.0%	\$ 7.250	\$ 137.750	+ shipping - see freight notes	88	
89	Tennis	8A	13	RIGID INFIELD DRAG MATS - HEAVY DUTY 6' Wide x 2' Long #RIDM6x2	Partac Peat Corp.	#RIDM6x2	EACH	\$ 180.00	5.0%	\$ 9.000	\$ 171.000	+ shipping - see freight notes	89	
90	Tennis	8A	13	RIGID INFIELD DRAG MATS - HEAVY DUTY 6' Wide x 3' Long #RIDM6x3	Partac Peat Corp.	#RIDM6x3	EACH	\$ 215.00	5.0%	\$ 10.750	\$ 204.250	+ shipping - see freight notes	90	
91	Tennis	8A	13	FLEXIBLE TURF & INFIELD DRAG MATS, STANDARD-DUTY 4' Wide x 6' Long NJ Plant #FTDM4X6-NJ	Keystone	#FTDM4X6-NJ	EACH	\$ 265.00	5.0%	\$ 13.250	\$ 251.750	+ shipping - see freight notes	91	
92	Tennis	8A	13	FLEXIBLE TURF & INFIELD DRAG MATS, STANDARD-DUTY 4' Wide x 6' Long PA Plant #FTDM4X6-PA	Keystone	#FTDM4X6-PA	EACH	\$ 245.00	5.0%	\$ 12.250	\$ 232.750	+ shipping - see freight notes	92	
93	Tennis	8A	13	FLEXIBLE TURF & INFIELD DRAG MATS, STANDARD-DUTY 5' Wide x 3' Long NJ Plant #FTDM5X3-NJ	Keystone	#FTDM5X3-NJ	EACH	\$ 190.00	5.0%	\$ 9.500	\$ 180.500	+ shipping - see freight notes	93	
94	Tennis	8A	13	FLEXIBLE TURF & INFIELD DRAG MATS, STANDARD-DUTY 5' Wide x 3' Long PA Plant #FTDM5X3-PA	Keystone	#FTDM5X3-PA	EACH	\$ 170.00	5.0%	\$ 8.500	\$ 161.500	+ shipping - see freight notes	94	
95	Tennis	8A	13	FLEXIBLE TURF & INFIELD DRAG MATS, STANDARD-DUTY 5' Wide x 5' Long NJ Plant #FTDM5X5-NJ	Keystone	#FTDM5X5-NJ	EACH	\$ 285.00	5.0%	\$ 14.250	\$ 270.750	+ shipping - see freight notes	95	
96	Tennis	8A	13	FLEXIBLE TURF & INFIELD DRAG MATS, STANDARD-DUTY 5' Wide x 5' Long PA Plant #FTDM5X5-PA	Keystone	#FTDM5X5-PA	EACH	\$ 265.00	5.0%	\$ 13.250	\$ 251.750	+ shipping - see freight notes	96	
97	Tennis	8A	13	FLEXIBLE TURF & INFIELD DRAG MATS, STANDARD-DUTY 6' Wide x 3' Long NJ Plant #FTDM6X3-NJ	Keystone	#FTDM6X3-NJ	EACH	\$ 225.00	5.0%	\$ 11.250	\$ 213.750	+ shipping - see freight notes	97	
98	Tennis	8A	13	FLEXIBLE TURF & INFIELD DRAG MATS, STANDARD-DUTY 6' Wide x 3' Long PA Plant #FTDM6X3-PA	Keystone	#FTDM6X3-PA	EACH	\$ 205.00	5.0%	\$ 10.250	\$ 194.750	+ shipping - see freight notes	98	

Bidding Company Name:				Partac Peat Corporation		Catalog Name:		8A - Tennis Court Surfaces, Equipment and Supplies						
No.	Product Category	Beam Clay Catalog Section #	Page#	Product Description	Manufacturer	Vendor SKU	Unit of Measure	Catalog List Price	Bid Discount Percentage	Discount Amt.	Net Effective Bid Price	Comments	No.	
99	Tennis	8A	13	FLEXIBLE TURF & INFIELD DRAG MATS, STANDARD-DUTY 6' Wide x 6' Long NJ Plant #FTDM6X6-NJ	Keystone	#FTDM6X6-NJ	EACH	\$ 395.00	5.0%	\$ 19.750	\$ 375.250	+ shipping - see freight notes	99	
100	Tennis	8A	13	FLEXIBLE TURF & INFIELD DRAG MATS, STANDARD-DUTY 6' Wide x 6' Long PA Plant #FTDM6X6-PA	Keystone	#FTDM6X6-PA	EACH	\$ 365.00	5.0%	\$ 18.250	\$ 346.750	+ shipping - see freight notes	100	
101	Tennis	8A	13	FLEXIBLE TURF & INFIELD DRAG MATS, STANDARD-DUTY 8' Wide x 8' Long NJ Plant #FTDM8X8-NJ	Keystone	#FTDM8X8-NJ	EACH	\$ 760.00	5.0%	\$ 38.000	\$ 722.000	+ shipping - see freight notes	101	
102	Tennis	8A	13	FLEXIBLE TURF & INFIELD DRAG MATS, STANDARD-DUTY 8' Wide x 8' Long PA Plant #FTDM8X8-PA	Keystone	#FTDM8X8-PA	EACH	\$ 725.00	5.0%	\$ 36.250	\$ 688.750	+ shipping - see freight notes	102	
103	Tennis	8A	13	FLEXIBLE TURF & INFIELD DRAG MATS, Small Flexible Drag Mat for Mounds - 2' Wide x 3 1/2' Long NJ Plant #FTDM2X3-1/2-NJ	Keystone	#FTDM2X3-1/2-NJ	EACH	\$ 105.00	5.0%	\$ 5.250	\$ 99.750	+ shipping - see freight notes	103	
104	Tennis	8A	13	FLEXIBLE TURF & INFIELD DRAG MATS, Small Flexible Drag Mat for Mounds - 2' Wide x 3 1/2' Long PA Plant #FTDM2X3-1/2-PA	Keystone	#FTDM2X3-1/2-PA	EACH	\$ 95.00	5.0%	\$ 4.750	\$ 90.250	+ shipping - see freight notes	104	
105	Tennis	8A	13	FLEXIBLE TURF & INFIELD DRAG MATS, Small Flexible Drag Mat for Mounds - 4' Wide x 2' Long - NJ Plant #FTDM4X2-NJ	Keystone	#FTDM4X2-NJ	EACH	\$ 110.00	5.0%	\$ 5.500	\$ 104.500	+ shipping - see freight notes	105	
106	Tennis	8A	13	FLEXIBLE TURF & INFIELD DRAG MATS, Small Flexible Drag Mat for Mounds - 4' Wide x 2' Long - PA Plant #FTDM4X2-PA	Keystone	#FTDM4X2-PA	EACH	\$ 100.00	5.0%	\$ 5.000	\$ 95.000	+ shipping - see freight notes	106	
107	Tennis	8A	13	FLEXIBLE TURF & INFIELD DRAG MATS, STANDARD-DUTY 3' Wide x 3' Long PA PLANT #FTDM3X3-PA	Keystone	#FTDM3X3-PA	EACH	\$ 110.00	5.0%	\$ 5.500	\$ 104.500	+ shipping - see freight notes	107	
108	Tennis	8A	13	FLEXIBLE TURF & INFIELD DRAG MATS, STANDARD-DUTY 3' Wide x 4' Long PA PLANT #FTDM3X4-PA	Keystone	#FTDM3X4-PA	EACH	\$ 135.00	5.0%	\$ 6.750	\$ 128.250	+ shipping - see freight notes	108	
109	Tennis	8A	13	FLEXIBLE TURF & INFIELD DRAG MATS, STANDARD-DUTY 3' Wide x 5' Long PA PLANT #FTDM3X5-PA	Keystone	#FTDM3X5-PA	EACH	\$ 165.00	5.0%	\$ 8.250	\$ 156.750	+ shipping - see freight notes	109	
110	Tennis	8A	13	FLEXIBLE TURF & INFIELD DRAG MATS, STANDARD-DUTY 4' Wide x 5' Long PA PLANT #FTDM4X5-PA	Keystone	#FTDM4X5-PA	EACH	\$ 179.00	5.0%	\$ 8.950	\$ 170.050	+ shipping - see freight notes	110	
111	Tennis	8A	13	FLEXIBLE TURF & INFIELD DRAG MATS, STANDARD-DUTY 6' Wide x 18" Long PA PLANT #FTM6X18-PA	Keystone	#FTM6X18-PA	EACH	\$ 120.00	5.0%	\$ 6.000	\$ 114.000	+ shipping - see freight notes	111	
112	Tennis	8A	13	FLEXIBLE TURF & INFIELD DRAG MATS, STANDARD-DUTY 6' Wide x 4' Long PA PLANT #FTDM6X4-PA	Keystone	#FTDM6X4-PA	EACH	\$ 260.00	5.0%	\$ 13.000	\$ 247.000	+ shipping - see freight notes	112	
113	Tennis	8A	13	FLEXIBLE TURF & INFIELD DRAG MATS, STANDARD-DUTY 6' Wide x 10' Long PA PLANT #FTDM6X10-PA	Keystone	#FTDM6X10-PA	EACH	\$ 585.00	5.0%	\$ 29.250	\$ 555.750	+ shipping - see freight notes	113	
114	Tennis	8A	13	FLEXIBLE TURF & INFIELD DRAG MATS, STANDARD-DUTY 6' Wide x 10' Long PA PLANT #FTDM6X10-NJ	Keystone	#FTDM6X10-NJ	EACH	\$ 620.00	5.0%	\$ 31.000	\$ 589.000	+ shipping - see freight notes	114	
115	Tennis	8A	13	FLEXIBLE TURF & INFIELD DRAG MATS, STANDARD-DUTY 6-1/2' Wide x 2' Long PA PLANT #FTDM6-1/2X2-PA	Keystone	#FTDM6-1/2X2-PA	EACH	\$ 160.00	5.0%	\$ 8.000	\$ 152.000	+ shipping - see freight notes	115	
116	Tennis	8A	13	FLEXIBLE TURF & INFIELD DRAG MATS, STANDARD-DUTY 6-1/2' Wide x 4' Long PA PLANT #FTDM6-1/2X4-PA	Keystone	#FTDM6-1/2X4-PA	EACH	\$ 280.00	5.0%	\$ 14.000	\$ 266.000	+ shipping - see freight notes	116	
117	Tennis	8A	13	FLEXIBLE TURF & INFIELD DRAG MATS, STANDARD-DUTY 8' Wide x 3' Long PA PLANT #FTDM8X3-PA	Keystone	#FTDM8X3-PA	EACH	\$ 300.00	5.0%	\$ 15.000	\$ 285.000	+ shipping - see freight notes	117	
118	Tennis	8A	13	FLEXIBLE TURF & INFIELD DRAG MATS, STANDARD-DUTY 8' Wide x 4' Long PA PLANT #FTDM8X4-PA	Keystone	#FTDM8X4-PA	EACH	\$ 385.00	5.0%	\$ 19.250	\$ 365.750	+ shipping - see freight notes	118	
119	Tennis	8A	13	FLEXIBLE TURF & INFIELD DRAG MATS, STANDARD-DUTY 8' Wide x 6' Long PA PLANT #FTDM8X6-PA	Keystone	#FTDM8X6-PA	EACH	\$ 550.00	5.0%	\$ 27.500	\$ 522.500	+ shipping - see freight notes	119	
120	Tennis	8A	13	FLEXIBLE TURF & INFIELD DRAG MATS, STANDARD-DUTY 10' Wide x 4' Long PA PLANT #FTDM10X4-PA	Keystone	#FTDM10X4-PA	EACH	\$ 475.00	5.0%	\$ 23.750	\$ 451.250	+ shipping - see freight notes	120	
121	Tennis	8A	13	FLEXIBLE TURF & INFIELD DRAG MATS, STANDARD-DUTY 10' Wide x 6' Long PA PLANT #FTDM10X6-PA	Keystone	#FTDM10X6-PA	EACH	\$ 685.00	5.0%	\$ 34.250	\$ 650.750	+ shipping - see freight notes	121	
122	Tennis	8A	13	FLEXIBLE TURF & INFIELD DRAG MATS, STANDARD-DUTY 10' Wide x 10' Long PA PLANT #FTDM10X10-PA	Keystone	#FTDM10X10-PA	EACH	\$ 1,100.00	5.0%	\$ 55.000	\$ 1,045.000	+ shipping - see freight notes	122	
123	Tennis	8A	13	FLEXIBLE TURF & INFIELD DRAG MATS, STANDARD-DUTY 12' Wide x 6' Long PA PLANT #FTDM12X6-PA	Keystone	#FTDM12X6-PA	EACH	\$ 825.00	5.0%	\$ 41.250	\$ 783.750	+ shipping - see freight notes	123	
124	Tennis	8A	13	FLEXIBLE TURF & INFIELD DRAG MATS, STANDARD-DUTY 12' Wide x 12' Long PA PLANT #FTDM12X12-PA	Keystone	#FTDM12X12-PA	EACH	\$ 1,575.00	5.0%	\$ 78.750	\$ 1,496.250	+ shipping - see freight notes	124	
125	Tennis	8A	14	FLEXIBLE DRAG MAT. 66" Wide x 4' Long #1149821	VPI	#1149821	EACH	\$ 350.00	5.0%	\$ 17.500	\$ 332.500	+ shipping - see freight notes	125	New Item
126	Tennis	8A	14	6' LEVELING BAR, Designed to attach to 6' wide flexible drag mat #123709	TSI	#123709	EACH	\$ 185.00	5.0%	\$ 9.250	\$ 175.750	+ shipping - see freight notes	126	New Item
127	Tennis	8A	14	HEAVY DUTY FLEXIBLE DRAG MAT 4' Wide x 4' Long #HDFDM4X4	Keystone	#HDFDM4X4	EACH	\$ 275.00	5.0%	\$ 13.750	\$ 261.250	+ shipping - see freight notes	127	
128	Tennis	8A	14	HEAVY DUTY FLEXIBLE DRAG MAT 6' Wide x 4' Long #HDFDM6X4	Keystone	#HDFDM6X4	EACH	\$ 395.00	5.0%	\$ 19.750	\$ 375.250	+ shipping - see freight notes	128	
129	Tennis	8A	14	HEAVY DUTY FLEXIBLE DRAG MAT 6' Wide x 5' Long #HDFDM6X5	Keystone	#HDFDM6X5	EACH	\$ 475.00	5.0%	\$ 23.750	\$ 451.250	+ shipping - see freight notes	129	
130	Tennis	8A	14	HEAVY DUTY FLEXIBLE DRAG MAT 6' Wide x 6' Long #HDFDM6X6	Keystone	#HDFDM6X6	EACH	\$ 555.00	5.0%	\$ 27.750	\$ 527.250	+ shipping - see freight notes	130	
131	Tennis	8A	14	HEAVY DUTY FLEXIBLE DRAG MAT 8' Wide x 6' Long #HDFDM8X6	Keystone	#HDFDM8X6	EACH	\$ 735.00	5.0%	\$ 36.750	\$ 698.250	+ shipping - see freight notes	131	

Bidding Company Name:				Partac Peat Corporation		Catalog Name:		8A - Tennis Court Surfaces, Equipment and Supplies						
No.	Product Category	Beam Clay Catalog Section #	Page#	Product Description	Manufacturer	Vendor SKU	Unit of Measure	Catalog List Price	Bid Discount Percentage	Discount Amt.	Net Effective Bid Price	Comments	No.	
132	Tennis	8A	14	HEAVY DUTY FLEXIBLE DRAG MAT 8' Wide x 8' Long #HDFDM8X8	Keystone	#HDFDM8X8	EACH	\$ 950.00	5.0%	\$ 47.500	\$ 902.500	+ shipping - see freight notes	132	
133	Tennis	8A	15	TENNIS COUR SCARIFER, Designed to break up clay, forty six 4.5" steel cutting teeth, 14" W x 6' L #BSDRAG	VPI	#BSDRAG	EACH	\$ 435.000	5.0%	\$ 21.750	\$ 413.250	+ shipping - see freight notes	133	New Item
134	Tennis	8A	15	TENNIS COURT SCARIFER WITH WHEELS, uses 4.5" sharpened and hardened steel cutting teeth, no=flat wheels allow you to roll for transport, pull chain is provided #BSDDRAG	VPI	#BSDDRAG	EACH	\$ 545.000	5.0%	\$ 27.250	\$ 517.750	+ shipping - see freight notes	134	New Item
135	Tennis	8A	15	TENNIS COURT SCARIFER WITH WHEELS, set of 2 wheels #BSDDWHL	VPI	#BSDDWHL	SET	\$ 195.000	5.0%	\$ 9.750	\$ 185.250	+ shipping - see freight notes	135	New Item
136	Tennis	8A	15	TENNIS COURT SCARIFERWITH WHEELS, Replacement Teeth #ZBDNAIL	VPI	#ZBDNAIL	PACKAGE	\$ 15.000	5.0%	\$ 0.750	\$ 14.250	+ shipping - see freight notes	136	New Item
137	Tennis	8A	16	COURT DEVIL SCARIFIERS, COURT DEVIL, Great for loosening and scarifying your tennis court surfaces, 48" width #146-3409	Hartru	#146-3409	EACH	\$ 1,595.000	5.0%	\$ 79.750	\$ 1,515.250	+ shipping - see freight notes	137	New Item
138	Tennis	8A	16	COURT DEVIL SCARIFIERS, COURT DEVIL JR., Great for loosening and scarifying your tennis court surfaces 16" width, #146-3408	Hartru	#146-3408	EACH	\$ 1,250.000	5.0%	\$ 62.500	\$ 1,187.500	+ shipping - see freight notes	138	New Item
139	Tennis	8A	16	TRU-FLOW TOP-DRESSERS, offers unmatched performance in distributing Fast-Dry Tennis Courts Surfacing, 24" Hand Spreader #124-3069	Hartru	#124-3069	EACH	\$ 950.000	5.0%	\$ 47.500	\$ 902.500	+ shipping - see freight notes	139	New Item
140	Tennis	8A	16	TRU-FLOW TOP-DRESSERS, offers unmatched performance in distributing Fast-Dry Tennis Courts Surfacing, 36" Tow Spreader #124-3065	Hartru	#124-3065	EACH	\$ 2,473.000	5.0%	\$ 123.650	\$ 2,349.350	+ shipping - see freight notes	140	New Item
141	Tennis	8A	16	TRU-FLOW TOP-DRESSERS, offers unmatched performance in distributing Fast-Dry Tennis Courts Surfacing, 54" Tow Spreader #124-3066	Hartru	#124-3066	EACH	\$ 2,894.000	5.0%	\$ 144.700	\$ 2,749.300	+ shipping - see freight notes	141	New Item
142	Tennis	8A	17	HAND ROLLER #85750	Mid West	#85750	EACH	\$ 325.000	5.0%	\$ 16.250	\$ 308.750	+ shipping - see freight notes	142	
143	Tennis	8A	16	HAND ROLLERS WITH CONVERTIBLE HANDLES - 18"D x 24"W #4908024	Gandy	#4908024	EACH	\$ 735.000	5.0%	\$ 36.750	\$ 698.250	+ shipping - see freight notes	143	
144	Tennis	8A	16	HAND ROLLERS WITH CONVERTIBLE HANDLES - 18"D x 36"W #4908036	Gandy	#4908036	EACH	\$ 1,030.000	5.0%	\$ 51.500	\$ 978.500	+ shipping - see freight notes	144	
145	Tennis	8A	16	HAND ROLLERS WITH CONVERTIBLE HANDLES - 18"D x 48"W #4908048	Gandy	#4908048	EACH	\$ 1,145.000	5.0%	\$ 57.250	\$ 1,087.750	+ shipping - see freight notes	145	
146	Tennis	8A	16	HAND ROLLERS WITH CONVERTIBLE HANDLES - 24"D x 24"W #49248024	Gandy	#49248024	EACH	\$ 825.000	5.0%	\$ 41.250	\$ 783.750	+ shipping - see freight notes	146	
147	Tennis	8A	16	HAND ROLLERS WITH CONVERTIBLE HANDLES - 24"D x 48"W #49249848	Gandy	#49249848	EACH	\$ 1,700.000	5.0%	\$ 85.000	\$ 1,615.000	+ shipping - see freight notes	147	
148	Tennis	8A	16	6' GANG ROLLER #499	Gandy	#499	EACH	\$ 2,350.000	5.0%	\$ 117.500	\$ 2,232.500	+ shipping - see freight notes	148	
149	Tennis	8A	16	12' GANG ROLLER #496	Gandy	#496	EACH	\$ 3,155.000	5.0%	\$ 157.750	\$ 2,997.250	+ shipping - see freight notes	149	
150	Tennis	8A	17	12' GANG ROLLER #4926	Gandy	#4926	EACH	\$ 4,800.000	5.0%	\$ 240.000	\$ 4,560.000	+ shipping - see freight notes	150	
151	Tennis	8A	18	YANKEE® ALUMINUM INFIELD RAKE - NERS24 - #0524 24" Blade	New England Rake	#0524	EACH	\$ 64.95	5.0%	\$ 3.248	\$ 61.703	+ shipping - see freight notes	151	
152	Tennis	8A	18	YANKEE® ALUMINUM INFIELD RAKE - NERS24-2P - #0524-2P 24" Blade	New England Rake	#0524-2P	EACH	\$ 120.00	5.0%	\$ 6.000	\$ 114.000	+ shipping - see freight notes	152	
153	Tennis	8A	18	YANKEE® ALUMINUM INFIELD RAKE - NERS30 - #0530 30" Blade	New England Rake	#0530	EACH	\$ 67.95	5.0%	\$ 3.398	\$ 64.553	+ shipping - see freight notes	153	
154	Tennis	8A	18	YANKEE® ALUMINUM INFIELD RAKE - NERS30-29 - #0530-2P 30" Blade	New England Rake	#0530-2P	EACH	\$ 126.00	5.0%	\$ 6.300	\$ 119.700	+ shipping - see freight notes	154	
155	Tennis	8A	18	YANKEE® ALUMINUM INFIELD RAKE - NERS36 - #0536 36" Blade	New England Rake	#0536	EACH	\$ 71.95	5.0%	\$ 3.598	\$ 68.353	+ shipping - see freight notes	155	
156	Tennis	8A	18	YANKEE® ALUMINUM INFIELD RAKE - NERS36-2P - #0536-2P 36" Blade	New England Rake	#0536-2P	EACH	\$ 133.00	5.0%	\$ 6.650	\$ 126.350	+ shipping - see freight notes	156	
157	Tennis	8A	18	YANKEE® ALUMINUM INFIELD RAKE - NERS42 - #0542 42" Blade	New England Rake	#0542	EACH	\$ 80.95	5.0%	\$ 4.048	\$ 76.903	+ shipping - see freight notes	157	
158	Tennis	8A	18	YANKEE® ALUMINUM INFIELD RAKE - NERS42-2P - #0542-2P 42" Blade	New England Rake	#0542-2P	EACH	\$ 150.00	5.0%	\$ 7.500	\$ 142.500	+ shipping - see freight notes	158	
159	Tennis	8A	18	YANKEE® ALUMINUM INFIELD RAKE - NERS48 - #0548 48" Blade	New England Rake	#0548	EACH	\$ 85.95	5.0%	\$ 4.298	\$ 81.653	+ shipping - see freight notes	159	
160	Tennis	8A	18	YANKEE® ALUMINUM INFIELD RAKE - NERS48-2P - #0548-2P 48" Blade	New England Rake	#0548-2P	EACH	\$ 157.00	5.0%	\$ 7.850	\$ 149.150	+ shipping - see freight notes	160	
161	Tennis	8A	18	YANKEE® ALUMINUM INFIELD RAKE - NERC14 - #0914 14" Blade	New England Rake	#0914	EACH	\$ 45.95	5.0%	\$ 2.298	\$ 43.653	+ shipping - see freight notes	161	
162	Tennis	8A	18	YANKEE® ALUMINUM INFIELD RAKE - NERC14-2P - #0914-2P 14" Blade	New England Rake	#0914-2P	EACH	\$ 84.00	5.0%	\$ 4.200	\$ 79.800	+ shipping - see freight notes	162	
163	Tennis	8A	18	YANKEE® ALUMINUM INFIELD RAKE - NERC24 - #0924 24" Blade	New England Rake	#0924	EACH	\$ 60.95	5.0%	\$ 3.048	\$ 57.903	+ shipping - see freight notes	163	
164	Tennis	8A	18	YANKEE® ALUMINUM INFIELD RAKE - NERC24-2P - #0924-2P 24" Blade	New England Rake	#0924-2P	EACH	\$ 112.00	5.0%	\$ 5.600	\$ 106.400	+ shipping - see freight notes	164	

Bidding Company Name:				Partac Peat Corporation		Catalog Name:		8A - Tennis Court Surfaces, Equipment and Supplies					
No.	Product Category	Beam Clay Catalog Section #	Page#	Product Description	Manufacturer	Vendor SKU	Unit of Measure	Catalog List Price	Bid Discount Percentage	Discount Amt.	Net Effective Bid Price	Comments	No.
165	Tennis	8A	18	YANKEE* ALUMINUM INFIELD RAKE - NERC30 - #0930 30" Blade	New England Rake	#0930	EACH	\$ 63.95	5.0%	\$ 3.198	\$ 60.753	+ shipping - see freight notes	165
166	Tennis	8A	18	YANKEE* ALUMINUM INFIELD RAKE - NERC30-2P - #0930 30" Blade	New England Rake	#0930-2P	EACH	\$ 118.00	5.0%	\$ 5.900	\$ 112.100	+ shipping - see freight notes	166
167	Tennis	8A	18	YANKEE* ALUMINUM INFIELD RAKE - NERC36 - #0936 36" Blade	New England Rake	#0936	EACH	\$ 67.95	5.0%	\$ 3.398	\$ 64.553	+ shipping - see freight notes	167
168	Tennis	8A	18	YANKEE* ALUMINUM INFIELD RAKE - NERC36-2P - #0936-2P 36" Blade	New England Rake	#0936-2P	EACH	\$ 123.00	5.0%	\$ 6.150	\$ 116.850	+ shipping - see freight notes	168
169	Tennis	8A	18	YANKEE* ALUMINUM INFIELD RAKE - NERC42 - #0942 42" Blade	New England Rake	#0942	EACH	\$ 75.95	5.0%	\$ 3.798	\$ 72.153	+ shipping - see freight notes	169
170	Tennis	8A	18	YANKEE* ALUMINUM INFIELD RAKE - NERC42-2P - #0942-2P 42" Blade	New England Rake	#0942-2P	EACH	\$ 140.00	5.0%	\$ 7.000	\$ 133.000	+ shipping - see freight notes	170
171	Tennis	8A	18	YANKEE* ALUMINUM INFIELD RAKE - NERC48 - #0948 48" Blade	New England Rake	#0948	EACH	\$ 79.95	5.0%	\$ 3.998	\$ 75.953	+ shipping - see freight notes	171
172	Tennis	8A	18	YANKEE* ALUMINUM INFIELD RAKE - NERC482-P - #0948-2P 48" Blade	New England Rake	#0948-2P	EACH	\$ 148.00	5.0%	\$ 7.400	\$ 140.600	+ shipping - see freight notes	172
173	Tennis	8A	18	Brace and Plug Replacement Kit— two 15" Braces & Hardware (For 24" / 30" / 36" Rakes) #BPRK-24	New England Rake	#BPRK-24	KIT	\$ 26.00	5.0%	\$ 1.300	\$ 24.700	+ shipping - see freight notes	173
174	Tennis	8A	18	Brace and Plug Replacement Kit— two 19" Braces & Hardware (For 42" / 48" Rakes) #BPRK-42	New England Rake	#BPRK-42	KIT	\$ 27.00	5.0%	\$ 1.350	\$ 25.650	+ shipping - see freight notes	174
175	Tennis	8A	18	Replacement Handle with Standard Grip 66" - #66RH w/SG	New England Rake	#66RH w/SG	EACH	\$ 30.00	5.0%	\$ 1.500	\$ 28.500	+ shipping - see freight notes	175
176	Tennis	8A	18	Replacement Handle with Standard Grip 84" - #84RH w/SG	New England Rake	#84RH w/SG	EACH	\$ 30.00	5.0%	\$ 1.500	\$ 28.500	+ shipping - see freight notes	176
177	Tennis	8A	18	YANKEE* PLUG PUSHER - NERL24 - #0624 24" Blade	New England Rake	#0624	EACH	\$ 52.95	5.0%	\$ 2.648	\$ 50.303	+ shipping - see freight notes	177
178	Tennis	8A	18	YANKEE* PLUG PUSHER - NERL24-2P - #0624 24" Blade	New England Rake	#0624-2P	EACH	\$ 95.00	5.0%	\$ 4.750	\$ 90.250	+ shipping - see freight notes	178
179	Tennis	8A	18	YANKEE* PLUG PUSHER - NERL - #0630 30" Blade	New England Rake	#0630	EACH	\$ 55.95	5.0%	\$ 2.798	\$ 53.153	+ shipping - see freight notes	179
180	Tennis	8A	18	YANKEE* PLUG PUSHER - NERL-2P - #0630-2P 30" Blade	New England Rake	#0630-2P	EACH	\$ 102.00	5.0%	\$ 5.100	\$ 96.900	+ shipping - see freight notes	180
181	Tennis	8A	18	YANKEE* PLUG PUSHER - NERL - #0636 36" Blade	New England Rake	#0636	EACH	\$ 58.95	5.0%	\$ 2.948	\$ 56.003	+ shipping - see freight notes	181
182	Tennis	8A	18	YANKEE* PLUG PUSHER - NERL-2P - #0636-2P 36" Blade	New England Rake	#0636-2P	EACH	\$ 106.00	5.0%	\$ 5.300	\$ 100.700	+ shipping - see freight notes	182
183	Tennis	8A	18	YANKEE* PLUG PUSHER - NERL42 - #0642 42" Blade	New England Rake	#0642	EACH	\$ 65.95	5.0%	\$ 3.298	\$ 62.653	+ shipping - see freight notes	183
184	Tennis	8A	18	YANKEE* PLUG PUSHER - NERL42-2P - #0642-2P 42" Blade	New England Rake	#0642-2P	EACH	\$ 120.00	5.0%	\$ 6.000	\$ 114.000	+ shipping - see freight notes	184
185	Tennis	8A	18	YANKEE* PLUG PUSHER - NERL48 - #0648 48" Blade	New England Rake	#0648	EACH	\$ 68.95	5.0%	\$ 3.448	\$ 65.503	+ shipping - see freight notes	185
186	Tennis	8A	18	YANKEE* PLUG PUSHER - NERL48-2P - #0648-2P 48" Blade	New England Rake	#0648-2P	EACH	\$ 126.00	5.0%	\$ 6.300	\$ 119.700	+ shipping - see freight notes	186
187	Tennis	8A	18	YANKEE* T-LUTE - NERA24 - #0624T 24" Blade	New England Rake	#0624T	EACH	\$ 59.95	5.0%	\$ 2.998	\$ 56.953	+ shipping - see freight notes	187
188	Tennis	8A	18	YANKEE* T-LUTE - NERA24-2P - #0624T-2P 24" Blade	New England Rake	#0624T-2P	EACH	\$ 103.00	5.0%	\$ 5.150	\$ 97.850	+ shipping - see freight notes	188
189	Tennis	8A	18	YANKEE* T-LUTE - NERA30 - #0630T 30" Blade	New England Rake	#0630T	EACH	\$ 61.95	5.0%	\$ 3.098	\$ 58.853	+ shipping - see freight notes	189
190	Tennis	8A	18	YANKEE* T-LUTE - NERA30-2P - #0630T-2P 30" Blade	New England Rake	#0630T-2P	EACH	\$ 109.00	5.0%	\$ 5.450	\$ 103.550	+ shipping - see freight notes	190
191	Tennis	8A	18	YANKEE* T-LUTE - NERA36 - 0636T 36" Blade	New England Rake	#0636T	EACH	\$ 62.95	5.0%	\$ 3.148	\$ 59.803	+ shipping - see freight notes	191
192	Tennis	8A	18	YANKEE* T-LUTE - NERA36-2P - 0636T-2P 36" Blade	New England Rake	#0636T-2P	EACH	\$ 115.00	5.0%	\$ 5.750	\$ 109.250	+ shipping - see freight notes	192
193	Tennis	8A	18	YANKEE* T-LUTE - NERA42 - #0642T 42" Blade	New England Rake	# 0642T	EACH	\$ 71.95	5.0%	\$ 3.598	\$ 68.353	+ shipping - see freight notes	193
194	Tennis	8A	18	YANKEE* T-LUTE - NERA42-2P - #0642T-2P 42" Blade	New England Rake	# 0642T-2P	EACH	\$ 131.00	5.0%	\$ 6.550	\$ 124.450	+ shipping - see freight notes	194
195	Tennis	8A	18	YANKEE* T-LUTE - NERA48 - #0648T 48" Blade	New England Rake	# 0648T	EACH	\$ 74.95	5.0%	\$ 3.748	\$ 71.203	+ shipping - see freight notes	195
196	Tennis	8A	18	YANKEE* T-LUTE - NERA48-2P - #0648T-2P 48" Blade	New England Rake	# 0648T-2P	EACH	\$ 137.00	5.0%	\$ 6.850	\$ 130.150	+ shipping - see freight notes	196
197	Tennis	8A	18	YANKEE* TRAP RAKE - #0510 18" Blade	New England Rake	#0510	EACH	\$ 34.95	5.0%	\$ 1.748	\$ 33.203	+ shipping - see freight notes	197



Bidding Company Name:				Partac Peat Corporation		Catalog Name:		8A - Tennis Court Surfaces, Equipment and Supplies					
No.	Product Category	Beam Clay Catalog Section #	Page#	Product Description	Manufacturer	Vendor SKU	Unit of Measure	Catalog List Price	Bid Discount Percentage	Discount Amt.	Net Effective Bid Price	Comments	No.
198	Tennis	8A	18	YANKEE® ROLLER SQUEEGEE - NON-ABSORBANT (BLACK) - #0736 - 36"	New England Rake	#0736	EACH	\$ 107.50	5.0%	\$ 5.375	\$ 102.125	+ shipping - see freight notes	198
199	Tennis	8A	18	YANKEE® ROLLER SQUEEGEE - NON-ABSORBANT (BLACK) -# 0748 48" Replacement Roller	New England Rake	#0748	EACH	\$ 45.00	5.0%	\$ 2.250	\$ 42.750	+ shipping - see freight notes	199
200	Tennis	8A	18	YANKEE® ROLLER SQUEEGEE - ABSORBANT (GREY) - #0724A 24" Wide	New England Rake	#0724A	EACH	\$ 104.50	5.0%	\$ 5.225	\$ 99.275	+ shipping - see freight notes	200
201	Tennis	8A	18	YANKEE® ROLLER SQUEEGEE - ABSORBANT (GREY) - #0736A 36" Wide	New England Rake	#0736A	EACH	\$ 114.50	5.0%	\$ 5.725	\$ 108.775	+ shipping - see freight notes	201
202	Tennis	8A	17	YANKEE® ROLLER SQUEEGEE - ABSORBANT (GREY) - #0748A 48" Replacement Roller	New England Rake	#0748A	EACH	\$ 50.00	5.0%	\$ 2.500	\$ 47.500	+ shipping - see freight notes	202
203	Tennis	8A	17	YANKEE® LITTER PICK - #0450 3/4" Tubular Handle with Pistol Grip, 41" Long	New England Rake	#0450	EACH	\$ 17.50	5.0%	\$ 0.875	\$ 16.625	+ shipping - see freight notes	203
204	Tennis	8A	17	YANKEE® LITTER PICK - #0402 Replacement Points for Above	New England Rake	#0402	EACH	\$ 5.95	5.0%	\$ 0.298	\$ 5.653	+ shipping - see freight notes	204
205	Tennis	8A	19	MIDWEST ALUMINUM RAKES - Court Rake - #12024 - 24" Blade	Midwest	#12024	EACH	\$ 64.950	5.0%	\$ 3.248	\$ 61.703	+ shipping - see freight notes	205
206	Tennis	8A	19	MIDWEST ALUMINUM RAKES - Court Rake - #12030 - 30" Blade	Midwest	#12030	EACH	\$ 68.950	5.0%	\$ 3.448	\$ 65.503	+ shipping - see freight notes	206
207	Tennis	8A	19	MIDWEST ALUMINUM RAKES - Court Rake - #12036 - 36" Blade	Midwest	#12036	EACH	\$ 70.950	5.0%	\$ 3.548	\$ 67.403	+ shipping - see freight notes	207
208	Tennis	8A	19	MIDWEST ALUMINUM RAKES - Court Rake - #12042 - 42" Blade	Midwest	#12042	EACH	\$ 77.940	5.0%	\$ 3.897	\$ 74.043	+ shipping - see freight notes	208
209	Tennis	8A	19	MIDWEST ALUMINUM RAKES - Court Rake - #12048 - 48" Blade	Midwest	#12048	EACH	\$ 82.950	5.0%	\$ 4.148	\$ 78.803	+ shipping - see freight notes	209
210	Tennis	8A	19	MIDWEST ALUMINUM RAKES - Chisel-Tooth Construction Rake -#20024 - 24" Blade	Midwest	#20024	EACH	\$ 69.950	5.0%	\$ 3.498	\$ 66.453	+ shipping - see freight notes	210
211	Tennis	8A	19	MIDWEST ALUMINUM RAKES - Chisel-Tooth Construction Rake - #20030 - 30" Blade	Midwest	#20030	EACH	\$ 73.950	5.0%	\$ 3.698	\$ 70.253	+ shipping - see freight notes	211
212	Tennis	8A	19	MIDWEST ALUMINUM RAKES - Chisel-Tooth Construction Rake - #20036 - 36" Blade	Midwest	#20036	EACH	\$ 78.950	5.0%	\$ 3.948	\$ 75.003	+ shipping - see freight notes	212
213	Tennis	8A	19	MIDWEST ALUMINUM RAKES - Chisel-Tooth Construction Rake - #20042 - 42" Blade	Midwest	#20042	EACH	\$ 83.950	5.0%	\$ 4.198	\$ 79.753	+ shipping - see freight notes	213
214	Tennis	8A	19	MIDWEST ALUMINUM RAKES - Chisel-Tooth Construction Rake -#20048 - 48" Blade	Midwest	#20048	EACH	\$ 88.950	5.0%	\$ 4.448	\$ 84.503	+ shipping - see freight notes	214
215	Tennis	8A	19	MIDWEST ALUMINUM RAKES - Chisel-Tooth Construction Rake - #20060 - 60" Blade	Midwest	#20060	EACH	\$ 98.950	5.0%	\$ 4.948	\$ 94.003	+ shipping - see freight notes	215
216	Tennis	8A	19	MIDWEST SPECIALTY TOOLS - Tennis Court Scarifer/Lute - Larger Teeth, 66" Handle - #56923 - 24" Blade	Midwest	#56923	EACH	\$ 52.950	5.0%	\$ 2.648	\$ 50.303	+ shipping - see freight notes	216
217	Tennis	8A	19	MIDWEST SPECIALTY TOOLS - Tennis Court Scarifer/Lute - Larger Teeth, 66" Handle - # 56929 - 30" Blade	Midwest	#56929	EACH	\$ 55.950	5.0%	\$ 2.798	\$ 53.153	+ shipping - see freight notes	217
218	Tennis	8A	19	MIDWEST SPECIALTY TOOLS - Tennis Court Scarifer/Lute - Larger Teeth, 66" Handle - #56935 - 36" Blade	Midwest	#56935	EACH	\$ 58.950	5.0%	\$ 2.948	\$ 56.003	+ shipping - see freight notes	218
219	Tennis	8A	19	MIDWEST SPECIALTY TOOLS - Tennis Court Scarifer/Lute - Finer Teeth, 66" Handle - #52936 - 36" Blade	Midwest	#52936	EACH	\$ 60.950	5.0%	\$ 3.048	\$ 57.903	+ shipping - see freight notes	219
220	Tennis	8A	19	MIDWEST SPECIALTY TOOLS - Tennis Court Scarifer/Lute - Larger Teeth, 82" Handle - #56924 - 24" Blade	Midwest	#56924	EACH	\$ 57.950	5.0%	\$ 2.898	\$ 55.053	+ shipping - see freight notes	220
221	Tennis	8A	19	MIDWEST SPECIALTY TOOLS - Tennis Court Scarifer/Lute - Larger Teeth, 82" Handle - #56930 - 30" Blade	Midwest	#56930	EACH	\$ 60.950	5.0%	\$ 3.048	\$ 57.903	+ shipping - see freight notes	221
222	Tennis	8A	19	MIDWEST SPECIALTY TOOLS - Tennis Court Scarifer/Lute - Larger Teeth, 82" Handle - #56936 - 36" Blade	Midwest	#56936	EACH	\$ 64.950	5.0%	\$ 3.248	\$ 61.703	+ shipping - see freight notes	222
223	Tennis	8A	19	MIDWEST SPECIALTY TOOLS - Tennis Court Scarifer/Lute - Finer Teeth, 82" Handle - #52037 - 36" Blade	Midwest	#52037	EACH	\$ 66.950	5.0%	\$ 3.348	\$ 63.603	+ shipping - see freight notes	223
224	Tennis	8A	19	MIDWEST SPECIALTY TOOLS - Tennis Court Scarifer/Lute - Finer Teeth, 82" Handle - #52038 - 36" Blade, 1-3/8" dia. Handle	Midwest	#52038	EACH	\$ 67.950	5.0%	\$ 3.398	\$ 64.553	+ shipping - see freight notes	224
225	Tennis	8A	19	MIDWEST ROLLER SQUEEGEES - #70924 - 24" Wide	Midwest	#70924	EACH	\$ 136.950	5.0%	\$ 6.848	\$ 130.103	+ shipping - see freight notes	225
226	Tennis	8A	19	MIDWEST ROLLER SQUEEGEES - #70936 - 36" Wide	Midwest	#70936	EACH	\$ 155.950	5.0%	\$ 7.798	\$ 148.153	+ shipping - see freight notes	226
227	Tennis	8A	19	MIDWEST ROLLER SQUEEGEES - #70948 - 48" Wide	Midwest	#70948	EACH	\$ 174.950	5.0%	\$ 8.748	\$ 166.203	+ shipping - see freight notes	227
228	Tennis	8A	19	MIDWEST ROLLER SQUEEGEES - PVA Absorbant for Tennis Courts - #72036 - 36" Wide	Midwest	#72036	EACH	\$ 158.950	5.0%	\$ 7.948	\$ 151.003	+ shipping - see freight notes	228
229	Tennis	8A	19	MIDWEST ROLLER SQUEEGEES - REPLACEMENT ROLLERS - #SA10047 - 24" Non Absorbant	Midwest	#SA10047	EACH	\$ 56.950	5.0%	\$ 2.848	\$ 54.103	+ shipping - see freight notes	229
230	Tennis	8A	19	MIDWEST ROLLER SQUEEGEES - REPLACEMENT ROLLERS - #SA10048 - 36" Non Absorbant	Midwest	#SA10048	EACH	\$ 70.950	5.0%	\$ 3.548	\$ 67.403	+ shipping - see freight notes	230

Bidding Company Name:				Partac Peat Corporation		Catalog Name:		8A - Tennis Court Surfaces, Equipment and Supplies					
No.	Product Category	Beam Clay Catalog Section #	Page#	Product Description	Manufacturer	Vendor SKU	Unit of Measure	Catalog List Price	Bid Discount Percentage	Discount Amt.	Net Effective Bid Price	Comments	No.
231	Tennis	8A	19	MIDWEST ROLLER SQUEEGEES - REPLACEMENT ROLLERS - #SA10049 - 48" Non Absorbant	Midwest	#SA10049	EACH	\$ 84.950	5.0%	\$ 4.248	\$ 80.703	+ shipping - see freight notes	231
232	Tennis	8A	19	MIDWEST ROLLER SQUEEGEES - REPLACEMENT ROLLERS - #A10051 - PVA Absorbant	Midwest	#SA10051	EACH	\$ 75.950	5.0%	\$ 3.798	\$ 72.153	+ shipping - see freight notes	232
233	Tennis	8A	20	MIDWEST SQUEEGEES - General Purpose - #76924 - 24" Blade	Midwest	#76924	EACH	\$ 65.950	5.0%	\$ 3.298	\$ 62.653	+ shipping - see freight notes	233
234	Tennis	8A	20	MIDWEST SQUEEGEES - General Purpose - #76936 - 36" Blade	Midwest	#76936	EACH	\$ 75.950	5.0%	\$ 3.798	\$ 72.153	+ shipping - see freight notes	234
235	Tennis	8A	20	MIDWEST SQUEEGEES - Straight Blade - #75936 - 36" Blade	Midwest	#75936	EACH	\$ 71.950	5.0%	\$ 3.598	\$ 68.353	+ shipping - see freight notes	235
236	Tennis	8A	20	MIDWEST BROOMS & BRUSHES - 7' WIDE MONSTER BROOM - #82084 - Two-Row Bristles	Midwest	#82084	EACH	\$ 198.950	5.0%	\$ 9.948	\$ 189.003	+ shipping - see freight notes	236
237	Tennis	8A	20	MIDWEST BROOMS & BRUSHES - 7' WIDE MONSTER BROOM - #83084 - Three-Row Bristles	Midwest	#83084	EACH	\$ 230.950	5.0%	\$ 11.548	\$ 219.403	+ shipping - see freight notes	237
238	Tennis	8A	20	MIDWEST BROOMS & BRUSHES - 7' WIDE MONSTER BROOM - #SP50067 - 7' Replacement Bristles (one row)	Midwest	#SP50067	EACH	\$ 42.950	5.0%	\$ 2.148	\$ 40.803	+ shipping - see freight notes	238
239	Tennis	8A	20	MIDWEST BROOMS & BRUSHES - DOUBLE PLAY MONSTER BROOM - #82384 - 84" Double Play Scarifier Monster Broom - Two-Row Bristles	Midwest	#82384	EACH	\$ 252.950	5.0%	\$ 12.648	\$ 240.303	+ shipping - see freight notes	239
240	Tennis	8A	20	MIDWEST BROOMS & BRUSHES - DOUBLE PLAY MONSTER BROOM - #SP50067 - 7' Replacement Bristles - One Row	Midwest	#SP50067	EACH	\$ 42.950	5.0%	\$ 2.148	\$ 40.803	+ shipping - see freight notes	240
241	Tennis	8A	21	7' WIDE MAHOGANY TENNIS COURT BROOM WITH 3 ROWS OF 7" FIBER BRISTLES & 2 STEEL HANDLES #311-7	Braun	#311-7	EACH	\$ 395.000	5.0%	\$ 19.750	\$ 375.250	+ shipping - see freight notes	241
242	Tennis	8A	21	7' WIDE ALUMINUM TENNIS COURT BROOM WITH 3 ROWS OF 5-1/2" GREEN POLYPRO BRISTLES & TWO 4' ALUMINUM HANDLES WITH 20" CROSS PIECE #411-7	Braun	#411-7	EACH	\$ 450.000	5.0%	\$ 22.500	\$ 427.500	+ shipping - see freight notes	242
243	Tennis	8A	21	7' WIDE ALUMINUM TENNIS COURT BROOM - CART PULL MODEL #411T	Braun	#411T	EACH	\$ 395.000	5.0%	\$ 19.750	\$ 375.250	+ shipping - see freight notes	243
244	Tennis	8A	21	DRI-BALL KIT #DB-KIT	Partac Peat Corporation	DB-KIT	KIT	\$ 75.000	5.0%	\$ 3.750	\$ 71.250	+ shipping - see freight notes	244